

The logo for Silver, featuring the word "Silver" in a bold, italicized, black sans-serif font, followed by a registered trademark symbol (®). The background of the page is a light gray with abstract, flowing, wavy lines that create a sense of motion and depth.

Silver[®]

Omistajan käsikirja Användarhandbok Owner's Manual Eignerhandbuch Manuel du propriétaire

Preface

Dear Silver boat owner! Thank you for buying a Silver boat. We hope that you will enjoy it!

This Owner's Manual is intended to help you use your boat safely. It provides a detailed description of the boat and related systems and accessories as well as information about the proper operation and care of the boat. Please read this manual carefully before using the boat for the first time.

Naturally, the Owner's Manual is no course in seamanship or boating safety. If this is your first boat or you have traded your old boat in for a new type that you are not familiar with, make sure, for your own comfort and safety, that you gain enough experience in handling and using the boat before accepting command. The dealer, boating clubs and national motor-boating and sailing associations will be happy to recommend local boating schools or competent instructors.

Make sure that the design category of your boat will meet the predicted wind conditions and wave heights and that you and your crew can handle the boat in such conditions. The wind and wave conditions corresponding to design categories A, B, and C range from a storm to strong winds involving a risk of exceptional waves and gusting. Although your boat is designed for such conditions, safe operation requires an able, trained crew and a well-maintained boat.

This Owner's Manual is not a detailed maintenance or troubleshooting guide. In case of problems, contact the manufacturer or your dealer. Always have the boat serviced and repaired and any alterations done by qualified personnel. Any modifications that may affect the safety of the boat should be evaluated, carried out and documented by a qualified person. The manufacturer accepts no liability for unauthorised modifications.

In some countries, a special boating licence or authorization may be required to operate the boat. These countries may also apply other additional regulations.

Always keep the boat in good condition. Consider wear and tear due to ageing, rough treatment or misuse. Any boat - irrespective of its strength - may be seriously damaged if it not used properly. Misuse is not part of safe boating. Always adjust your speed and direction of travel to the prevailing swell.

If your boat is equipped with a life raft, read its operating instructions with care. The boat should always have the appropriate safety equipment (life vests, safety harness, etc.) according to the type of boat, weather conditions, etc. In some countries, such equipment is compulsory. The crew should be familiar with the use of all the safety equipment and emergency manoeuvres (for example, reboarding a person falling overboard, towing, etc.). Sailing schools and clubs organise sea rescue exercises on a regular basis.

All persons onboard the boat should wear suitable flotation device (life vest / boating vest) when on deck. Note that in some countries it is mandatory to wear a flotation device at all times when onboard.

KEEP THIS OWNER'S MANUAL IN A SAFE PLACE AND GIVE IT TO THE NEXT OWNER IF YOU SELL THE BOAT.

Before departure

Read this Owner's Manual carefully.
Always check the following items before departure:

Prevailing weather and weather forecast

Consider wind, wave height, and visibility. Is the design category of your boat, its size and accessories as well as the skills of the master and crew sufficient for the waters in which you intend to travel? In strong winds and high seas, all hatches must be closed to prevent water from entering the boat.

Load-carrying capacity

Do not overload the boat, and distribute the load evenly. Do not place heavy objects in elevated positions because they may jeopardise the stability of the boat.

Passengers

Make sure that there are enough life vests for all onboard. Before departure explain the duties of every passenger during the trip.

Fuel

Make sure that you have enough fuel, including reserves in case of foul weather.

Engine and equipment

Check the operation and condition of the steering system, electrical equipment and the battery and carry out the daily checks specified in the engine manual. Ensure the seaworthiness of the boat by checking for fuel and water leaks, make sure that all the safety gear is onboard, etc. Make sure that the water level in the bilge is at its minimum.

Ventilation

If the engine compartment in your boat is equipped with a fan, let it run for at least 4 minutes before starting the engine. Start the engine following the manufacturer's instructions. Ensure adequate ventilation around fuel tank(s) to reduce the risk of fire.

Stowage of goods

Make sure that all the goods are secured so that they cannot move in heavy seas and strong winds.

Nautical charts

If you are not navigating a route that you know by heart, make sure that you have enough charts to make the trip safely.

Departure and landing manoeuvres

Agree with the crew members who will manage what rope. Make sure that mooring lines, etc., cannot get entangled in the propeller when departing or landing.

Consult the engine manual for information concerning the engine.

Contents

1	General	141			
<hr/>					
2	Definitions	141			
<hr/>					
3	Warranty	141			
<hr/>					
4	Commissioning	141			
	4.1 Registration	141			
	4.2 Insurance	142			
	4.3 Training	142			
<hr/>					
5	Characteristics and operation of the boat	142			
	5.1 General	142			
	5.2 Basic boat data	142			
	5.3 Maximum number of persons the boat is designed to carry	143			
	5.4 Loading	143			
	5.5 Engine and propeller	144			
	5.6 Stability and flooding	148			
	5.6.1 Openings in hull and deck	148			
	5.6.2 Bilge pumps and drainage	149			
	5.7 Prevention of fire and explosion	149			
	5.7.1 Engines	149			
	5.7.2 Other fuel-burning systems	149			
	5.7.3 Fire protection	155			
	5.8 Electrical system	156			
	5.9 Handling characteristics	156			
	5.9.1 Driving at high speeds	156			
	5.9.2 Visibility from the steering position	157			
	5.10 Proper seamanship - recommendations and instructions	157			
	5.10.1 Protection from falling overboard and means of re-boarding	157			
	5.10.2 Stowage of life raft	157			
	5.10.3 Ventilation	158			
	5.10.4 Securing loose items	158			
	5.10.5 Respect for the environment	158			
	5.10.6 Anchoring, mooring and towing	158			
	5.10.7 Trailing	159			
<hr/>					
6	Maintenance and winterizing	160			
	6.1 Measures before winter docking	160			
	6.2 Washing and cleaning	160			
	6.3 Winter storage and servicing	160			
	6.4 Measures before launching	161			
<hr/>					
7	Repairs	161			
	Appendices	167			

1 General

This Owner's Manual helps you get to know your boat and learn about its characteristics, maintenance and servicing. The manuals for the accessories installed in the boat are included, and reference is frequently made to them. Naturally, you can supplement this manual with the manuals for any additional accessories you may have retrofitted. Space is provided for your own notes at the end of the manual.

2 Definitions

The following texts are used in this manual to indicate risk or danger:

DANGER! Means that there is a serious risk of injury or death unless proper precautionary action is taken.

WARNING! Means that there is a risk of injury or death unless proper precautionary action is taken.

CAUTION! Reminds of a safe procedure or highlights an unsafe procedure that may lead to an injury or damage to the boat or its components.

This manual makes use of the SI units of measurements. Other units may be used in brackets in places.

3 Warranty

The manufacturer gives the boat and the accessories installed at the boatyard a two-year warranty in accordance with the terms indicated on the warranty card. Warranties for the following components are given by the respective manufacturers:

- engine and drive
- trim tabs
- stove, refrigerator, and heater
- compass
- instruments
- navigation equipment.

The warranty certificates for these devices and the contact details of the suppliers are attached. In case of inquiries concerning other equipment, please contact

TerhiTec Oy, Sorvitie 4, FI-63700 Ähtäri
Tel. +358 (0)20 510 200, fax +358 (0)20 510 201
silverveneet@terhitec.fi

4 Commissioning

4.1 Registration

Under the Finnish Boating Decree, motorboats with an engine with an output at least 15kW or hull length at least 5,5 meters, must be entered in the National Craft Register. For more details, contact the local register office (maistraatti). A person operating a registered boat must be at least 15 years of age.

4.2 Insurance

Boat insurance may cover damage sustained at sea or when the boat is transported over land or docked. Check the insurance liability before the boat is lifted out of water. Indirectly, insurance may also improve safety at sea: in case of an accident, you can concentrate on saving human life. Contact an insurance company for information about boat insurance.

4.3 Training

No one is born a master. Many books on boating and navigation are available. Check about the possibilities of attending navigation and boating courses. While they will get you started, true confidence in handling, navigation, mooring and anchoring is only achieved through long practice. It is also advisable to find out about the local boating clubs and their activities.

5 Characteristics and operation of the boat

5.1 General

This Owner's Manual is not intended to be a complete servicing and maintenance guide. However, it will help you get to know your boat and its characteristics and operate it safely.

5.2 Basic boat data

The technical data on the various Silver boat models is listed in the following table:

Design category:

Category C: Designed for voyages where conditions up to and including wind force 6 (Beaufort scale), or 14 m/s, and significant wave heights of up to 2 m may be experienced (see Note below). Such conditions may be encountered on open lakes, estuaries, and coastal waters in reasonable weather conditions.

Category D: Designed for voyages where conditions up to and including wind force 4 (Beaufort scale), or 8 m/s, and significant wave heights of up to 0.3 m may be experienced (with occasional wave heights of 0.5 m). Such conditions may be encountered in sheltered waters and coastal waters in good weather.

Note:

Significant wave height means the average height of the highest 1/3rd of the waves over a given period, which is equivalent to the wave height estimated by an experienced observer. Waves of double that height may occasionally be experienced.

Main dimensions and capacities:

The boat's length, beam, draught, total weight, etc., and tank capacities are indicated in the Technical Specifications in Appendix 1.

Builder's plate:

A builder's plate that shows some of the above information is affixed within the field of vision of the pilot. Supplementary data is provided in the appropriate sections of this manual.

5.3 Maximum number of persons the boat is designed to carry

The maximum numbers of persons the different Silver boat models are designed to carry are indicated in the following table. The seats intended for the passengers are indicated in Fig. 1.

WARNING! Never exceed the maximum number of passengers. Irrespective of the number of people onboard, the combined weight of the passengers and equipment may never exceed the maximum permissible load (see Loading). Always use the seats provided.

5.4 Loading

The maximum permissible load that Silver boats are designed to carry include the following:

- a) total weight of the persons onboard (an adult is assumed to weigh 75 kg and a child 37.5 kg)
- b) basic equipment
- c) weight of the liquids carried in portable containers (water, fuel, etc.)
- d) total weight of the consumable liquids in integrated tanks (water, fuel, etc.) (with full tanks)

The recommended weight only includes the weight components listed above.

WARNING: When loading things aboard, never exceed the maximum permissible load. Position the load carefully to ensure the optimum balance of the boat (even keel). Do not place heavy objects in elevated positions.

Maximum number of passengers:

Silver Beaver 450	5
Silver Fox DC/BR 485	5
Silver Wolf DC/BR 510	6
Silver Hawk BR/CC 540	7
Silver Shark BR/CC 540	7
Silver Eagle BR 650/CC 630	7
Silver Eagle Cabin 650	7
Silver Eagle WA 650	7
Silver Eagle Star Cabin 650	6
Silver Condor 730	8

Maximum permissible load:

Silver Beaver 450	430 kg
Silver Fox DC/BR 485	435 kg
Silver Wolf DC/BR 510	500 kg
Silver Hawk BR/CC 540	615 kg
Silver Shark BR/CC 580	525 kg
Silver Eagle BR 650	675 kg
Silver Eagle CC 630	705 kg
Silver Eagle Cabin 650	675 kg
Silver Eagle WA 650	675 kg
Silver Eagle Star Cabin 650	600 kg
Silver Condor 730	1005 kg

Maximum permissible load includes:

	Basic equipment, kg	Fuel in portable containers, kg	Fuel in integrated tanks, kg
Silver Beaver 450	10	30	
Silver Fox DC/BR 485	10	60	
Silver Wolf DC/BR 510	10	40	
Silver Hawk BR/CC 540	10		80
Silver Shark BR/CC 580	11		100
Silver Eagle BR 650	15		100
Silver Eagle CC 630	15		100
Silver Eagle WA 650	20		100
Silver Eagle Star Cabin 650	20		100
Silver Condor 730	25		250

5.5 Engine and propeller

The maximum engine outputs that may be used on Silver boats are indicated in the following table. Follow the motor manufacturer's instructions in the selection of the propeller.

Maximum permissible engine outputs:

Silver Beaver 450	30 kW (40 hv)
Silver Fox DC	37 kW (50 hv)
Silver Fox BR 485	45 kW (60 hv)
Silver Wolf DC/BR 510	45 kW (60 hv)
Silver Hawk BR/CC 540	75 kW (100 hv)
Silver Shark BR/CC 580	86 kW (115 hv)
Silver Eagle BR 650	130 kW (175 hv)
Silver Eagle CC 630	112 kW (150 hv)
Silver Eagle Cabin 650	112 kW (150 hv)
Silver Eagle WA 650	130 kW (175 hv)
Silver Eagle Star Cabin 650	112 kW (150 hv)
Silver Condor 730	220 kW (300 hv)

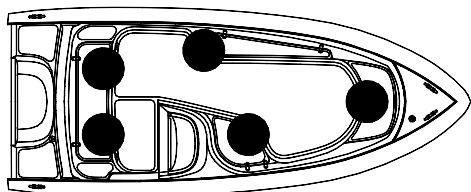

Silver Beaver 450

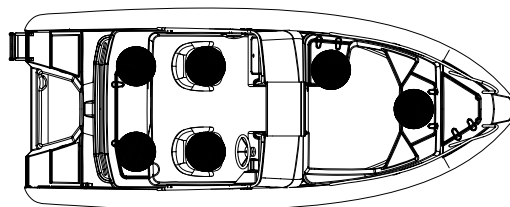

Wolf BR 510

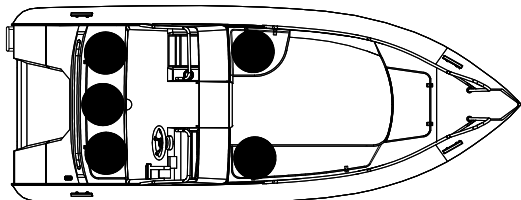

Silver Fox DC 485

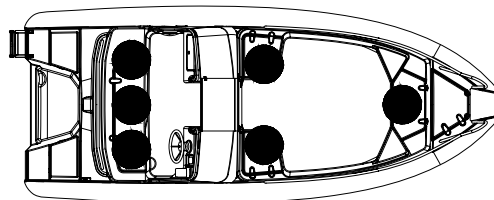

Wolf DC 510

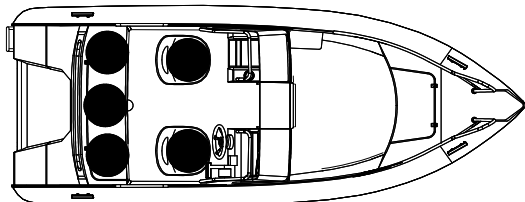

Silver Fox BR 485

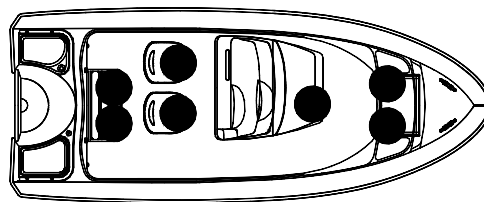

Silver Hawk CC 540

Fig. 1. Seats for maximum permissible number of passengers.

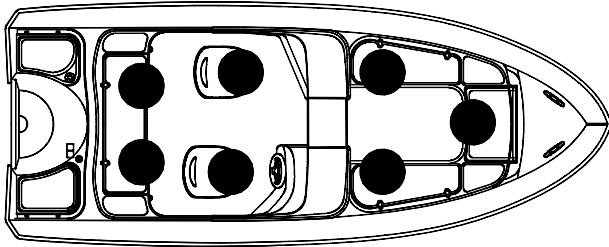

Silver Hawk BR 540

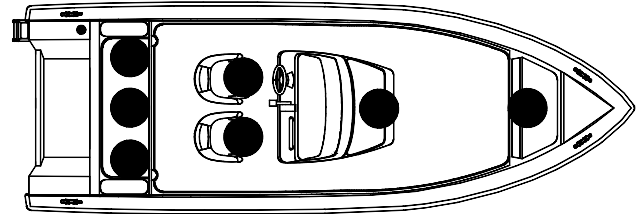

Silver Shark CC and Silver Eagle CC

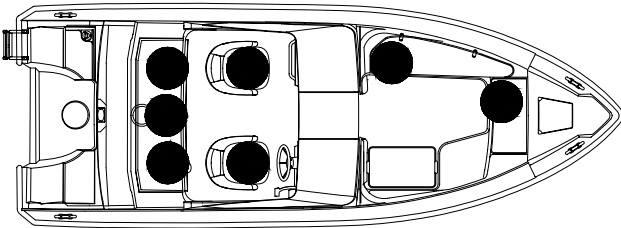

Silver Shark BR 580

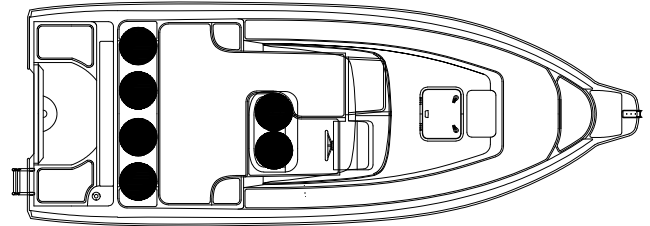

Silver Eagle WA 650

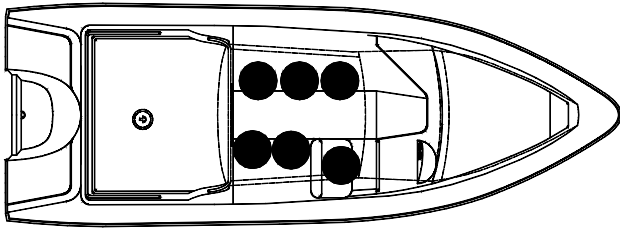

Silver Star Cabin 650

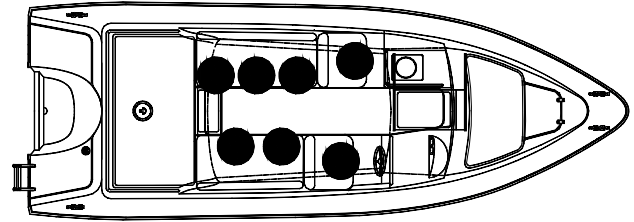

Silver Cabin 650

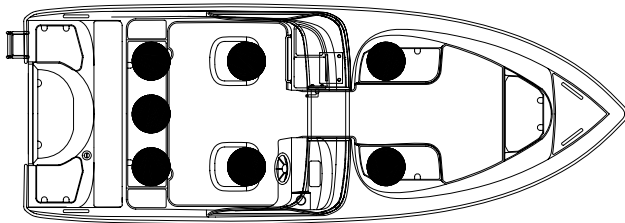

Silver Eagle 650

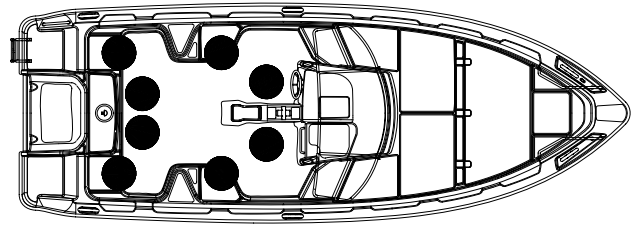

Silver Condor 730

Fig. 1. Seats for maximum permissible number of passengers.

5.6 Stability and flooding

5.6.1 Openings in hull and deck

The location of thru-hulls and related shutoff valves are indicated in Fig. 5.

Silver boats are lined with a self-draining fibreglass interior. The self-draining outlets in the aft corners of the interior must be kept open and free from debris to ensure drainage. The Silver Colibri is self-draining only when unloaded.

CAUTION! Despite self-drainage, water may find its way into the bilge through motor well openings and inspection doors. Check the bilge level before setting out to the sea and drain it with the bilge pump provided.

On Silver Eagle, Silver Shark, and Silver Hawk 540, the deck self-draining outlets can be closed with ball valves. On the other models they can be closed with plugs. If the boat is to carry a heavier-than-normal load, close the self-draining outlets to prevent the ingress of water.

With Silver Cab models, keep the cabin doors and hatches closed in strong winds and heavy seas.

WARNING! If you want to keep the cabin roof hatch open when under way, secure it in the open position with the locking mechanism. Failing that, a sudden movement of the boat may cause the roof hatch to close without warning and cause injuries. Secure all the other hatches and doors in the same way.

5.6.2 Bilge pumps and drainage

Silver boats are equipped with an automatic electric bilge pump in the location shown in Fig. 5. When the sensor detects the presence of water in the bilge, the pump drains it automatically. The pump is always in standby mode irrespective of the position of the main circuit breaker provided that the battery has been installed and connected. The electric bilge pump can also be operated from the switch panel. The capacity of the bilge pump is about 45 litres/min. Boats without a manual electric pump installed do not feature an automatic emptying function: in this case, the pump is engaged by a switch in the switch panel.

The electric bilge pump is operated from the switch panel described in Section 5.8.

Carry out regular checks to ensure that the ends of the bilge pump suction hoses are not blocked by debris.

WARNING! The bilge pump system is not designed for controlling leaks resulting from running aground or other such damage.

CAUTION! Check the bilge pump regularly for correct operation. Remove any debris from the pump suction inlets.

5.7 Prevention of fire and explosion

5.7.1 Engines

If the engine compartment in your boat is equipped with a fan, let it run for at least 4 minutes before starting the engine as indicated in the warning sign in front of the pilot. Also make sure that the ven-

tilation openings are open and free from debris, etc. After starting the engine, check the cooling water circulation.

Before refuelling switch off the engine, stove, heater and put out any cigarettes. Do not operate any switches or devices that may produce sparks.

The fuel inlet () is located on the stern deck.

When refuelling at a service station, do not use a plastic funnel because it will prevent the discharge of static voltage between the filler pistol and fuel inlet bushing. After refuelling (check tank capacity in Section 5), make sure that no fuel has leaked into the bilge or engine well. Wipe off any fuel splashes right away.

Space has been provided for one slip tank under the aft seat. Do not keep any reserve canisters in a non-ventilated space or leave them loose.

Do not leave any loose objects in the engine well that may get in touch with hot engine parts or damage the fuel lines. Check the fuel lines once a year for wear.

5.7.2 Other fuel-burning systems

If the boat is equipped with a paraffin heater, separate instructions are provided with the boat. Use only high-grade paraffin for fuel. Before refuelling switch off the engine, stove, heater and put out any cigarettes. Do not operate any switches or devices that may produce sparks. Wipe off any fuel splashes right away.

Switch symbols on Silver boats





symbol	explanation
	navigation lights
	anchor light
	windshield wiper
	bilge pump
	trim tabs
	interior light
	heater

Fig. 2. Switch panel and fuses.

Beaver



Fox

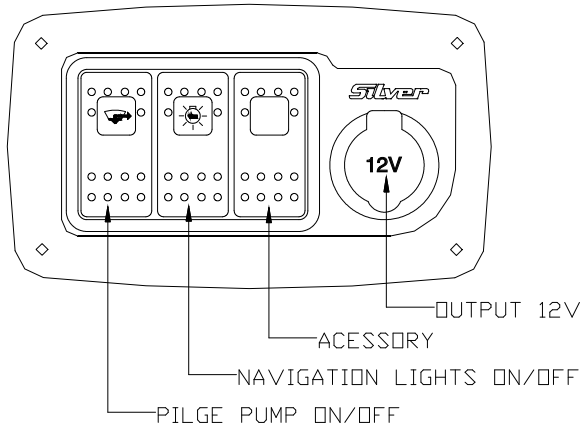
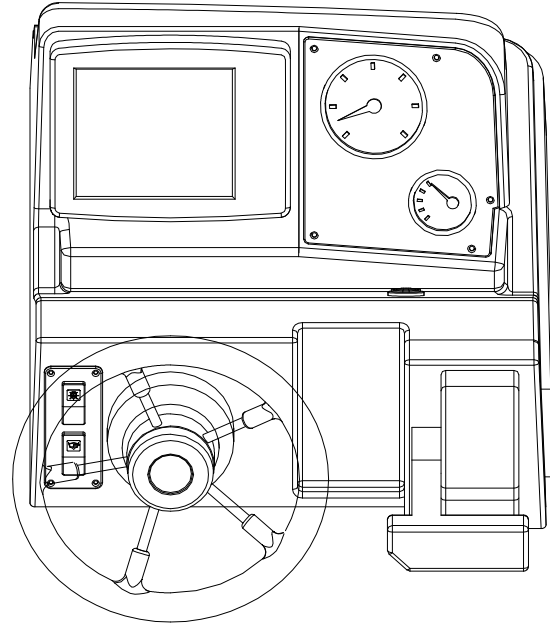

16 Fig. 2. Switch panel and fuses.

Hawk CC

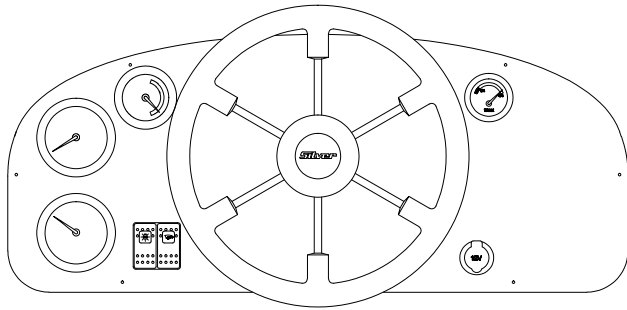

Hawk BR

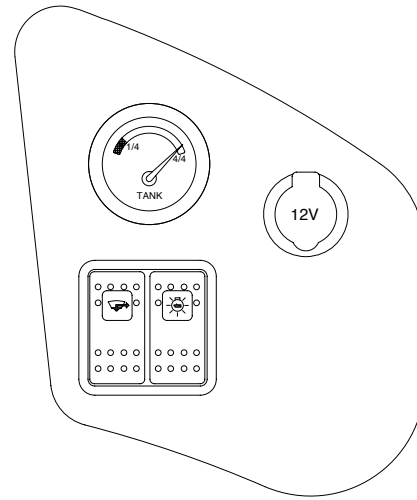
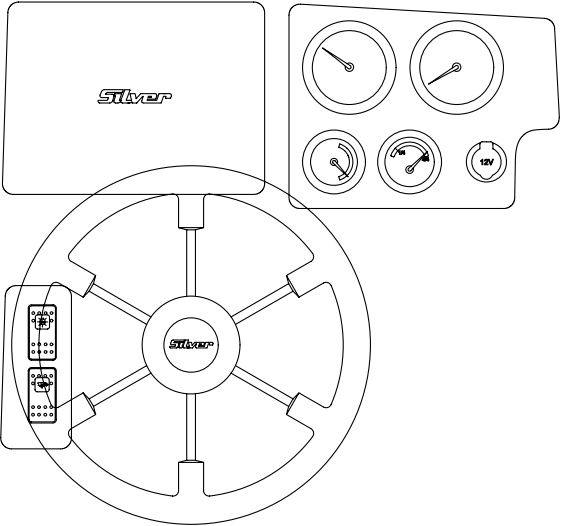
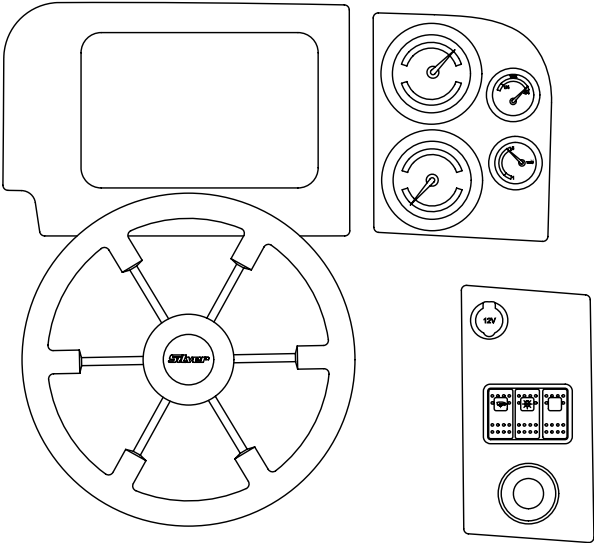

Fig. 2. Switch panel and fuses.

Wolf DC/BR



Shark BR 580



18 Fig. 2. Switch panel and fuses.

Shark CC / Eagle CC

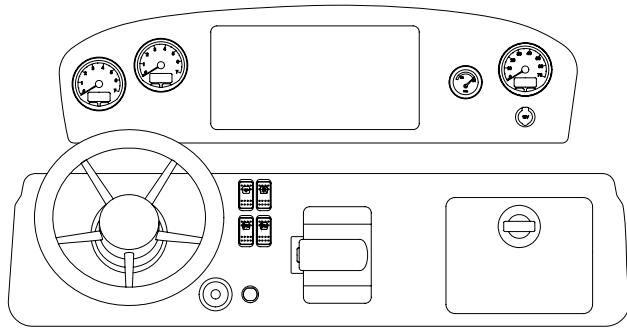

Eagle BR 650

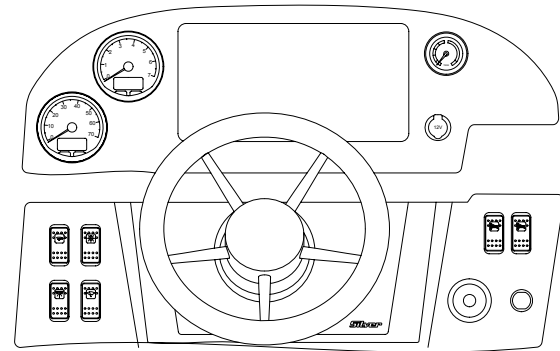
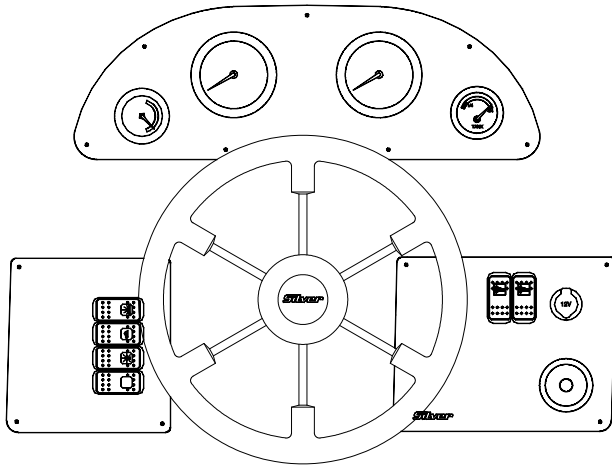
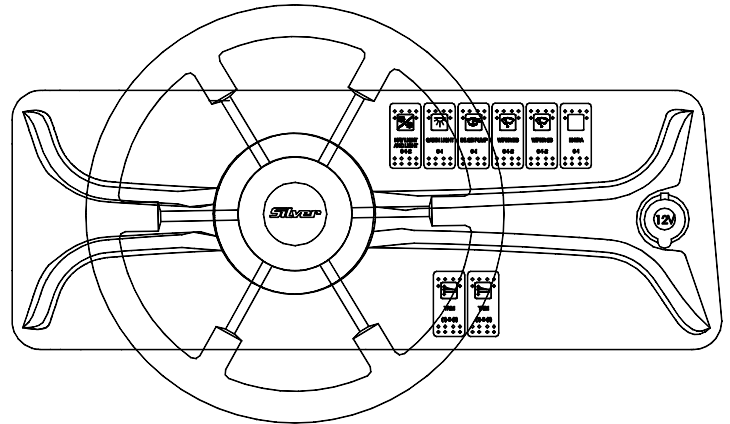

Fig. 2. Switch panel and fuses.

Eagle WA



Eagle Cabin / Star Cabin



Condor

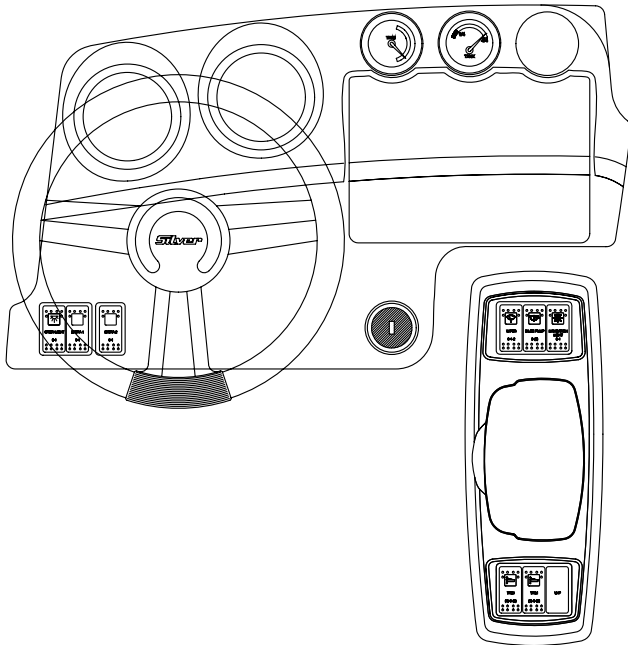

5.7.3 Fire protection

All Silver boats come with a 2 kg hand-held fire extinguisher (13A70BC). Moreover, boats with petrol inboard motors have a fixed extinguishing system in the engine compartment. Fire extinguishers need to be serviced annually. Extinguishers older than 10 years may not be used unless a new pressure test is carried out. If the extinguisher is replaced, the new device must have the same extinguishing capacity.

Keep the bilge clean and check the systems for any fuel or fuel vapour leaks regularly.

Do not suspend any freely hanging curtains or other fabrics above or in the vicinity of the stove. Nor keep any flammable liquids in the engine compartment. If any non-flammable materials are stored in the engine compartment, secure them in place to ensure that they cannot fall off or hit the machinery or block access to or from the space.

Boats fitted with a fixed extinguishing system have an indicator light on the switch panel. If the light goes out when the ignition is on, either the extinguishing system has been triggered or there is a malfunction.

Never

- leave the boat unattended when the stove or heater is in operation.
- make any modifications to any boat systems (particularly the electrical, fuel or gas system) or allow any unauthorised person to do so.
- fill any fuel tanks or change gas bottles when the engine is running or the stove or heater is in operation.
- smoke when handling fuel or gas.
- obstruct or make any modifications to the boat ventilation system

5.8 Electrical system

The wiring diagrams of the boat are shown in a special appendix.

Location and operation of the main circuit breaker:

- On the right-hand side of the steering position
- "OFF": Both batteries are off.
- "1": Battery 1 being used as service battery, charger recharging both batteries.
- "2": Battery 2 being used as service battery, charger recharging both batteries.

The locations of the instruments and switches for the electrical equipment are shown in Fig. 6. The circuit fuses are located next to the appropriate switch and the fuse sizes are indicated in Fig. 6. The Finnboat ce model features resetting fuses that can be reconnected after being blown by flipping up the tipping switch.

If you leave the boat for a longer time, switch off the current from the main circuit breaker.

When removing or re-installing batteries, take care not to touch the poles of the battery with any metal object simultaneously or the pole and the metal hull of the boat.

Use only the charger installed in the boat or a device of equal capacity to recharge the batteries. Excessive recharging current causes a risk of explosion.

When connecting the system to shore power, first connect the boat outlet and then the jetty outlet.

WARNING! Never touch any part of a live AC system.

WARNING! When the boat is connected to shore power, never swim near the boat. A defective cable may cause an electric shock.

CAUTION! Never switch off the current from the main circuit breaker while the engine is running.

CAUTION! Do not use the metal hull of the boat as an electrical conductor.

5.9 Handling characteristics

5.9.1 Driving at high speeds

Do not use the boat if the engine output exceeds the maximum power indicated on the builder's plate.

A few basic rules for adjusting the power trim:

- Use the "bow down" position when making the boat plane.
- When the boat is planning and if the swell is low, lift the bow until the boat starts to porpoise or the propeller loses its grip. Then lower the bow slightly until the boat stabilises. Optimise the power trim by means of the log.
- In head sea, lower the bow for a smoother ride. In following sea, lift the bow to prevent it from nose-diving.

See the engine manual as well.

Normally, an outboard engine is installed in the lowest position on the transom.

WARNING! At high speeds, adjust the power trim with great care - it alters the behaviour of the boat radically. Do not

drive the boat with the bow too low to prevent the boat from turning abruptly.

Do not drive at high speeds with a negative power trim (bow low). If you do so, the boat may veer to one side and become unstable when turning.

WARNING! Waves make it harder to control the boat and tend to make it heel. Reduce the speed when waves get high.

Learn and follow the rules of the waterways and comply with the COLREG (Convention on the International Regulations for Preventing Collisions at Sea) regulations. Navigate with care and use new or updated nautical charts.

Always adjust your speed to prevailing conditions. Consider the following:

- Swell (listen to your passengers)
- Wake (greatest when starting to plane and smallest at displacement speeds below 6 knots). Observe the No Waves signs. Reduce your speed to diminish the wake out of respect for others and for your own safety.
- Visibility (islands, fog, rain, sun in your eyes)
- Familiarity with the route (time required for navigation)
- Width of the channel (other boaters, noise and wake hitting the shore)
- Room required for stopping and evasive manoeuvring.

5.9.2 Visibility from the steering position

When the weather is fine and the sea calm, boating is simple provided that you keep a sharp lookout in accordance with the COLREG regulations. Make sure that you have the best possible visibility from the steering position:

- Position the passengers, curtains, etc., in such a way that they do not limit your field of vision.
- Do not drive continuously at the planing threshold because the high bow will decrease visibility.
- Control the attitude of the boat by adjusting the power trim to prevent the rising bow from reducing visibility.
- Use windshield wipers when necessary.
- In poor visibility conditions, open the cabin roof hatch to see better.
- Keep a lookout astern particularly in shipping lanes.

When it is dark or visibility is limited (e.g. fog), switch on the navigation lights. Turn off the cabin lights if the reflections decrease visibility.

5.10 Proper seamanship – recommendations and instructions

5.10.1 Protection from falling overboard and means of re-boarding

In calm seas, the easiest way of re-boarding is to use the swim ladder mounted onto the transom. The ladder can also be pulled down by a person who is in water. Fig. 4.

5.10.2 Stowage of life raft

On Silver Eagle Cabin models, a stowage point for the life raft is provided in the open space astern.

5.10.3 Ventilation

The stove draws the oxygen required for combustion from the cabin and generates combustion gases. Provide adequate ventilation when using the stove.

At slow speeds under unfavourable circumstances (following wind), exhaust fumes may find their way into the cabin through the open door. If you smell any exhaust fumes, keep the door closed and ventilate the cabin via the deck hatches.

Provide adequate ventilation in the sleeping compartment as well.

5.10.4 Securing loose items

Secure heavy loose items, such as anchors, firmly before departure.

5.10.5 Respect for the environment

Protecting the watercourses and the environment is a point of honour for a boater. Do not

- spill fuel and oil
- release toilet waste into the water
- dump rubbish overboard or leave it on the shore
- release detergents or solvents into the water
- make loud noise at sea and in marinas
- make large wakes particularly in narrow straits and shallow waters.

Comply with all local laws and regulations. Read the international regulations on preventing the contamination of the marine environment (MARPOL) and follow them.

5.10.6 Anchoring, mooring and towing

Always moor your boat in a sheltered location as the conditions may change quickly. The mooring lines should be fitted with compensators to reduce jerking. Use large enough fenders to avoid rubbing.

Ensure that the aluminium hull of the boat in dock or buoy mooring does not come in touch with any other metal part (e.g. locking or buoy chain), as this may cause galvanic corrosion between the metals.

We recommend the following mooring line thicknesses and anchor weights for your boat:

Mooring lines	ø 12 mm
Anchor line	ø 12 mm length 35 m
Anchor chain	ø 8 mm length 3 m

To calculate the right weight of the anchor for your boat, use the following formula:

$$\begin{aligned} & \text{Weight of boat (tonnes) + length (m) + beam (m)} \\ & = \text{anchor weight (kg)} \end{aligned}$$

A lightweight anchor may be lighter than this, but it should still be 60% of the weight yielded by the formula.

WARNING! Do not try to stop the boat by hand. Never put your hand or foot between the boat and the jetty, bank or another boat. Practice landing in easy conditions and apply engine power with restraint but determination.

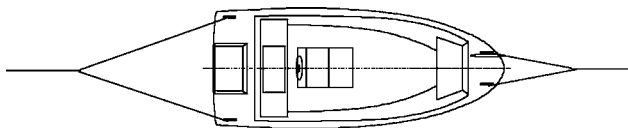

Fig. 3. Location of strong points for towing, anchoring and mooring.

Strong point strengths:

Silver Beaver 450	10,8 kN
Silver Fox DC/BR 485	12,1 kN
Silver Wolf DC/BR 510	13 kN
Silver Hawk BR/CC 540	14 kN
Silver Shark BR/CC 580	15,5 kN
Silver Eagle CC 630	17,4 kN
Silver Eagle BR 650	17,4 kN
Silver Star Cabin 650	17,9 kN
Silver Cabin 650	17,9 kN
Silver Eagle WA 650	17,9 kN
Silver Condor 730	17,9 kN

CAUTION! When mooring the boat, consider the shifting of the wind, rise or fall of the water level, wake, etc. Additional advice is available from your insurance company, etc.

When towing another boat, use a floating towing line of sufficient strength. Start the towing operation at low speed without jerking and overloading the engine. If you are towing a dinghy, adjust the length of the towing line so that the dinghy rides on the wake. How-

ever, in narrow straits and heavy seas, pull the dinghy closer to reduce yawing. Secure all the equipment in the dinghy firmly in case it capsizes. Cover the dinghy on open waters to prevent splashes from filling it.

When towing or being towed, attach the towing line to the strong points indicated in Fig. 3.

WARNING! The towing line is subjected to high tension. If it snaps, the free end may whiplash dangerously. Always use a sufficiently thick rope and stay clear of it when towing.

5.10.7 Trailering

A Silver boat can be easily transported on a trailer. Make sure that the trailer is suitable for your boat: that there are enough supports to reduce point loads, its load-bearing capacity is sufficient to carry the boat, engine, equipment, etc.

The maximum permissible weight of the trailer is indicated in the vehicle registration.

The trailer keel supports should carry most of the weight of the boat. Adjust the side supports to ensure that the boat is not jolted from side to side. Check once more that the trailer is securely hitched to the towing hook.

When you reach your destination, clean the boat. Thoroughly rinse any mud and salt that has accumulated on the boat. Take extra care to rinse the aluminium sides to prevent salt from leaving permanent marks on the surface.

When you reach your destination, clean the boat. Thoroughly rinse any mud and salt that has accumulated on the boat. Take extra care

to rinse the aluminium sides to prevent salt from leaving permanent marks on the surface.

CAUTION! The trailer should be slightly front-heavy. Make sure that the boat is firmly attached to the trailer and its weight is uniformly distributed over the supports. A jolting boat will keep hitting individual supports and the hull may be damaged in the process.

6 Maintenance and winterizing

Consult the engine manual for servicing recommendations. Carry out the necessary measures or have them performed by an authorized service centre. Other items requiring regular maintenance include:

- steering and controls
- bilge pumps
- heater
- stove
- fire extinguisher
- canopy.

Carry out the servicing in accordance with specific instructions and manuals.

6.1 Measures before winter docking

If subzero temperatures are to be expected, drain the cooling water from the engine as described in the engine manual. Lift your Silver boat out of water well before the lake or sea freezes. Your boat is not designed for use in ice or for in-water storage in winter. Before lifting the boat on land, it is advisable to carry out the following operations:

- 26 - Wash the hull.

- Drain all bilge water from the boat and remove equipment that is not needed. However, leave the safety equipment, such as the fire extinguisher, in the boat.

6.2 Washing and cleaning

Keep the boat clean to improve comfort and safety and to maintain its re-sale value.

Usually it is enough to clean and wax the deck and sides. Use sweet water and ordinary boat shampoos for washing. Do not use strong solvents as they tend to dull the gloss of reinforced plastic surfaces. To remove chafes or ingrained dirt, use a mildly abrasive polish.

Clean the bottom immediately after the boat is lifted out of water. Algae and slime are easy to remove before they dry.

6.3 Winter storage and servicing

Service the engine and other equipment for the winter in accordance with the instructions provided. If you leave the boat out of doors or in damp conditions, remove all textiles and other materials that may get mouldy or corrode in dampness. Wash the ropes in sweet water and replace any worn ropes.

Open the plug in the transom to remove all water accumulated in the bilge to prevent it from causing damage when freezing. Also, leave the ball valves half-open to prevent freezing.

Electrical instruments should also be protected against oxidization and theft by removing and storing them in a dry place for the winter. Remove the batteries and place them in a warm, dry location. Recharge the batteries at least twice during the winter. Spray a suitable de-moisturizing and anti-corrosion agent to electrical connectors.

Cover the boat to prevent the accumulation of snow inside the boat. However, provide adequate ventilation. Normally, no snow accumulates on top of the tarpaulin if the ridge angle is at least 90°. Use a tarpaulin measuring 6 × 4 m.

CAUTION! The tarpaulin and its lashing ropes may not be in direct contact with the boat surface because when fluttering and chafing they leave black marks on the aluminium surface that are hard to remove.

6.4 Measures before launching

Repair any damage to the gelcoat or have it repaired in accordance with Section 7.

For sea conditions, fouling growth on the boat bottom must be prevented using antifouling paint. A fouled bottom and propeller increase fuel consumption considerably. However, if the boat is moored at a river mouth or in low-salt water, or if the boat is lifted out of water at least once a week, no antifouling is usually required. Follow the paint manufacturer's instructions carefully. If you remove the existing paint, remember that the dust or sludge produced during the process is toxic. No antifouling is required or recommended on sweet-water inland lakes.

CAUTION! Do not paint over the zinc anodes, log sensor or the piston rods of the trim tab hydraulic cylinders. Do not apply paint that contains copper to aluminium parts. Follow the paint manufacturer's instructions. Paints containing lead and copper are corrosive to aluminium.

Carry out the required engine servicing in accordance with the manual. Check the operation of electrical equipment and remove oxidization from fuse connections, etc.

After launching the boat, open all the thru-hull valves and check hoses and connectors for leaks. The location of thru-hulls is shown in Section 5. Bring all the safety gear to the boat before setting out.

7 Repairs

In case of engine or equipment failure, contact the respective supplier.

Minor surface (gelcoat) damage on the hull and deck can be repaired by the owner himself. However, doing a good job requires skill and effort:

- tape the surface around the damaged spot to protect it
- grind the perimeter of the dent to remove sharp edges and degrease with acetone
- mix 1.5 to 2.0% of hardener in the gelcoat
- apply the gelcoat to the spot to be repaired so that it remains slightly higher than the surrounding area
- attach a tape carefully over the repaired spot
- after the gelcoat has cured, remove the tape and sand the repaired spot flush if necessary to make it neat
- polish the repaired spot with a polishing paste.

The colour scheme of the boat and more detailed instructions for making repairs are available from the boatyard or your gelcoat dealer.

When fitting new accessories, etc., to the boat, use only aluminium or acid resistant steel rivets and screws. Isolate all equipment made of metals other than aluminium from the hull and aluminium parts.

CAUTION! Certain retro-fittings and modifications may, if not correctly performed, damage the boat and compromise safety. Contact the manufacturer or some other authorised yard before making new grounding connections, hatches, etc., or hiring somebody else to do it.

CAUTION! Always switch off the current before any work on electrical equipment. If you need to replace any electrical components, make sure that they are compatible with the onboard voltage.

CAUTION! Tape that will be applied on the side striping can harm the original tape surface. Please make sure that the material will comply.

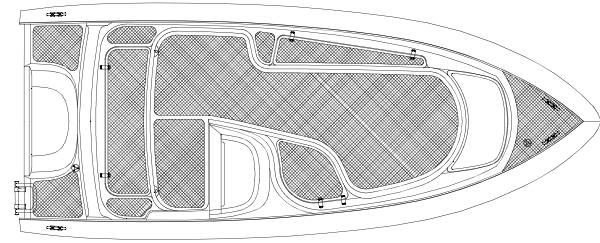

Silver Beaver 450

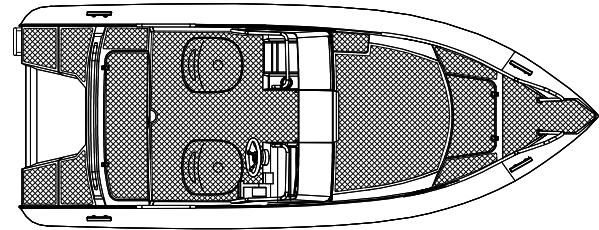

Silver Fox BR 485

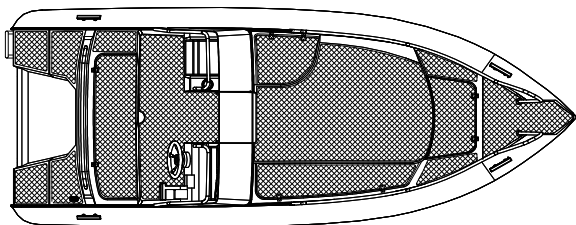

Silver Fox DC

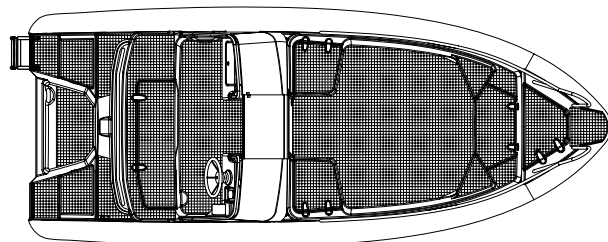

Silver Wolf DC 510

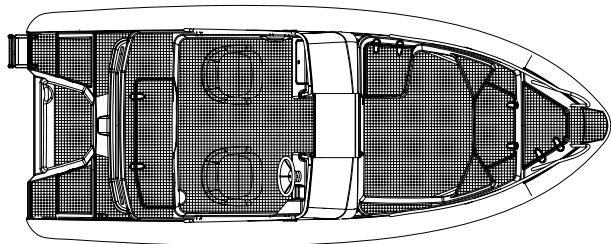

Silver Wolf BR 510

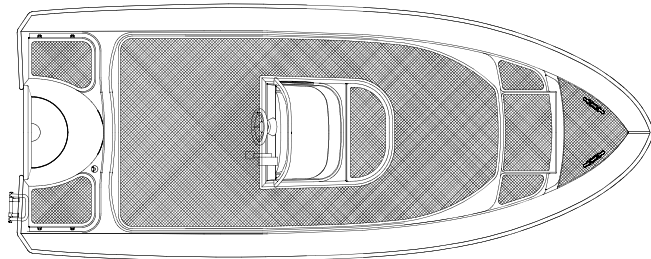

Silver Hawk CC 540

Fig. 4. Boarding ladder position and anti-slip surfaces.

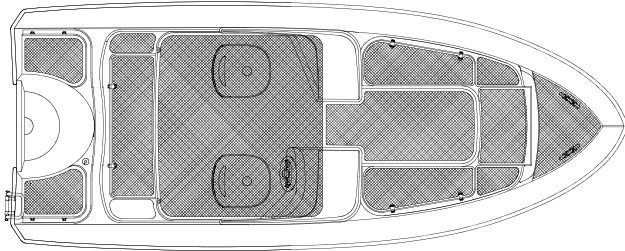

Silver Hawk BR 540

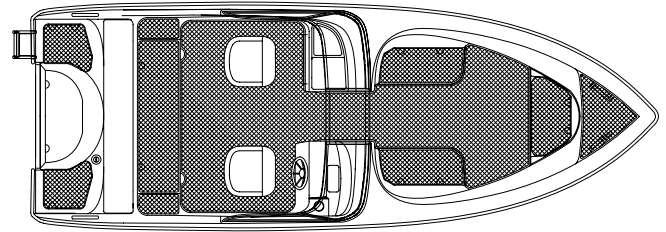

Silver Eagle BR 650

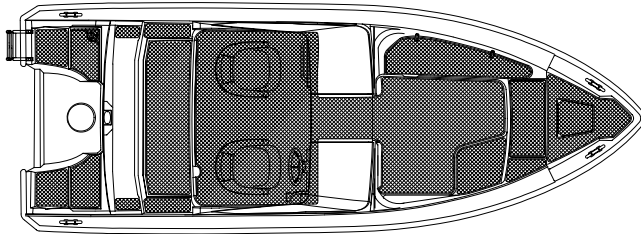

Silver Shark BR 580

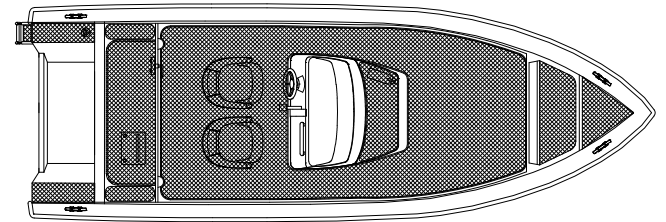

Silver Eagle CC 630 and Silver Shark CC

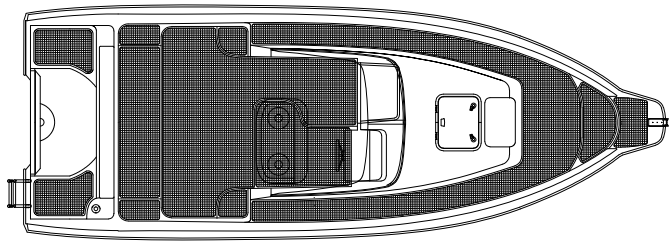

Silver Eagle WA 650

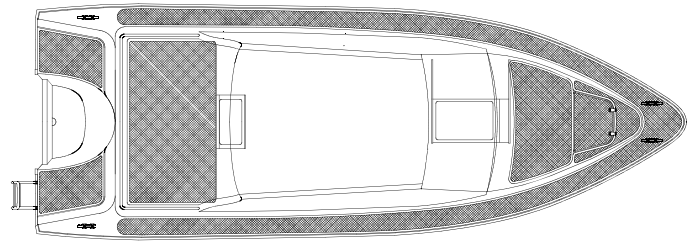

Silver Cabin 650

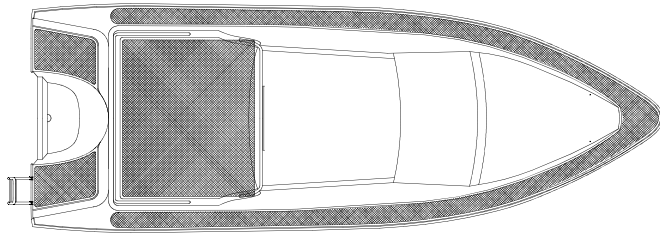

Silver Star Cabin 650

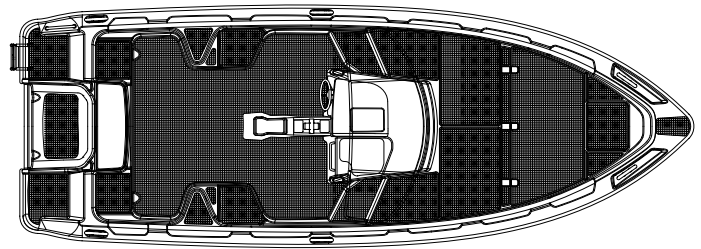

Silver Condor 730

Fig. 4. Boarding ladder position and anti-slip surfaces.

Appendices

GENERAL ARRANGEMENT DRAWINGS OF THE BOATS

DECLARATION OF CONFORMITY

TECHNICAL SPECIFICATIONS AND TANK CAPACITIES

WIRING DIAGRAM

TANK DIAGRAM

Silver Beaver 450

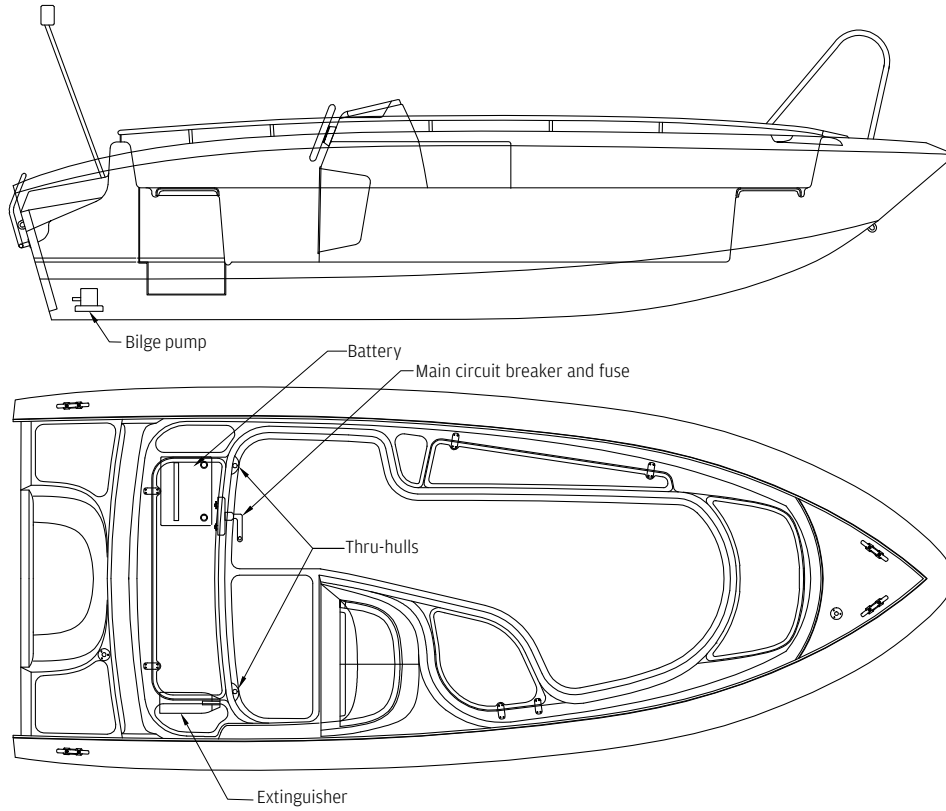

34 Fig. 5. Location of thru-hulls, shutoff valves and bilge pumps.

Silver Fox DC 485

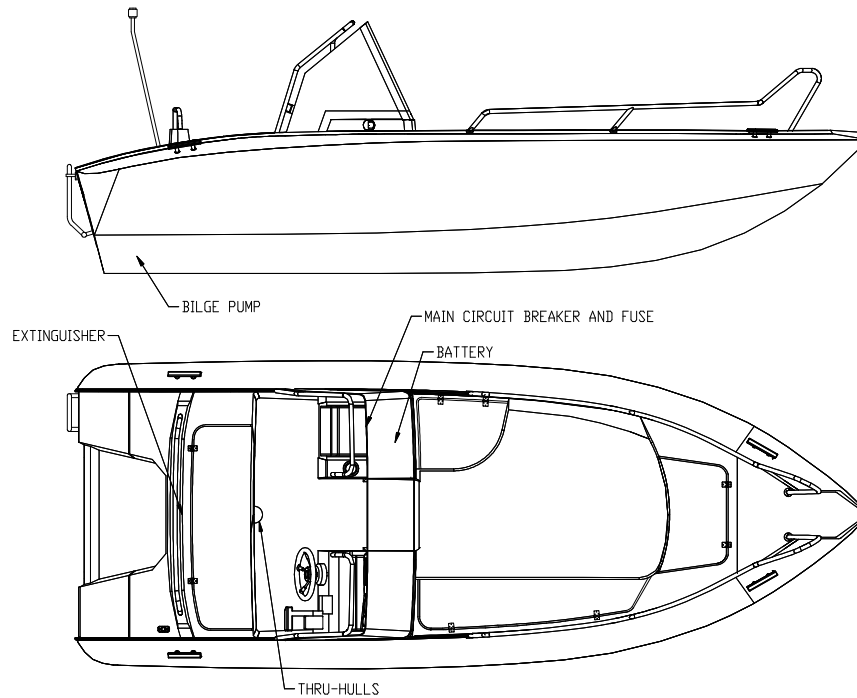
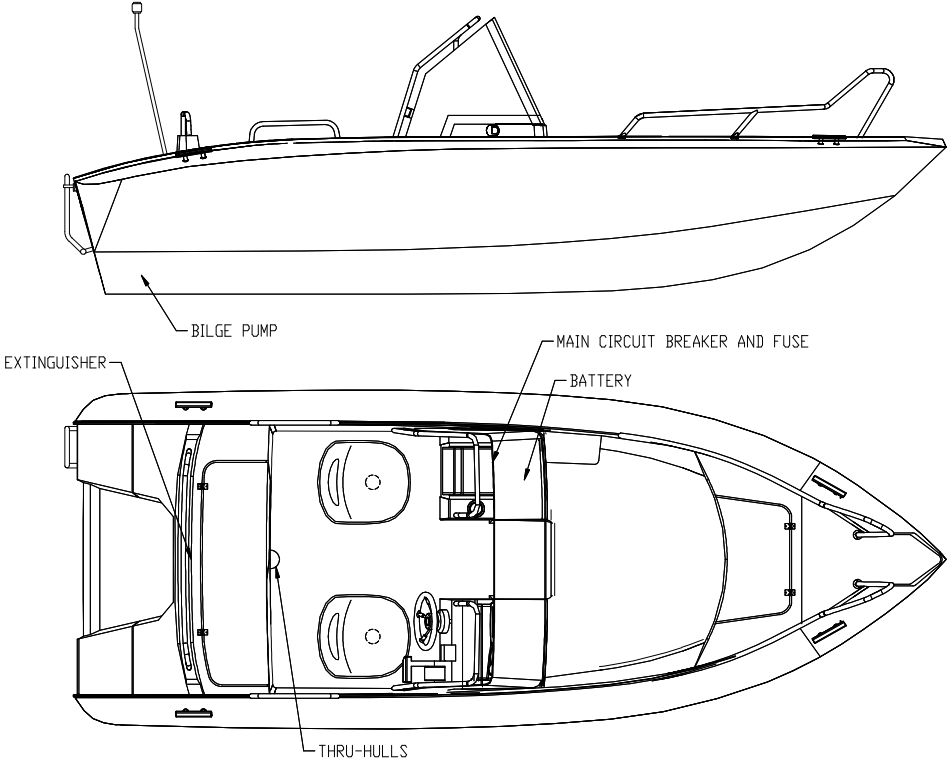

Fig. 5. Location of thru-hulls, shutoff valves and bilge pumps.

Silver Fox BR



36 Fig. 5. Location of thru-hulls, shutoff valves and bilge pumps.

Silver Wolf DC 510

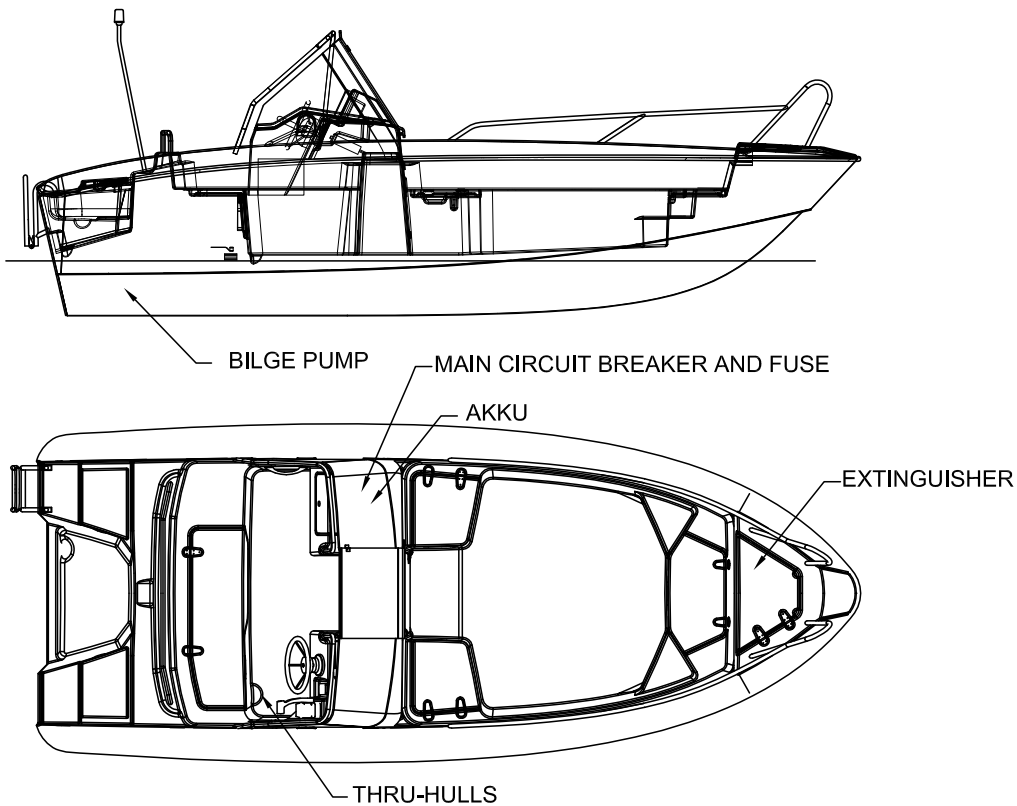
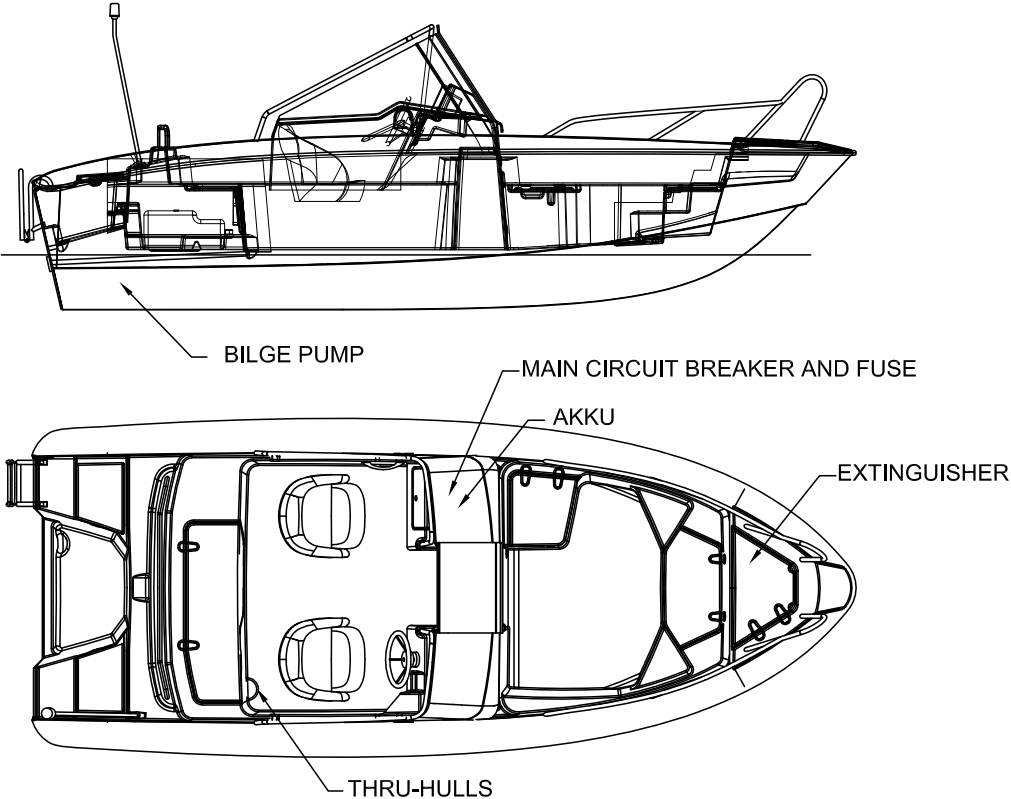

Fig. 5. Location of thru-hulls, shutoff valves and bilge pumps.

Silver Wolf BR 510



38 Fig. 5. Location of thru-hulls, shutoff valves and bilge pumps.

Silver Hawk CC 540

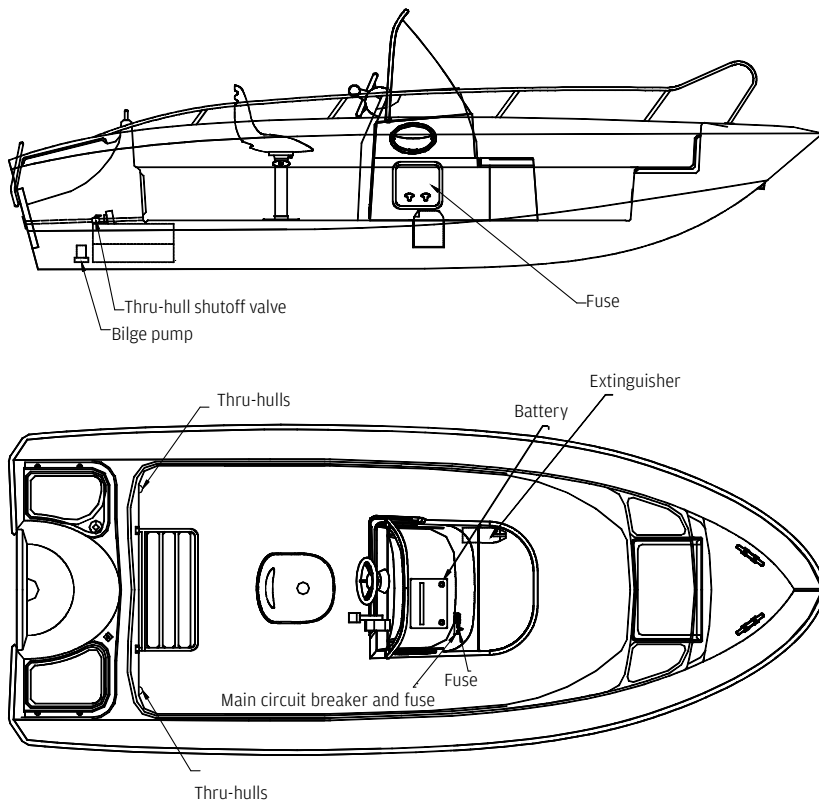
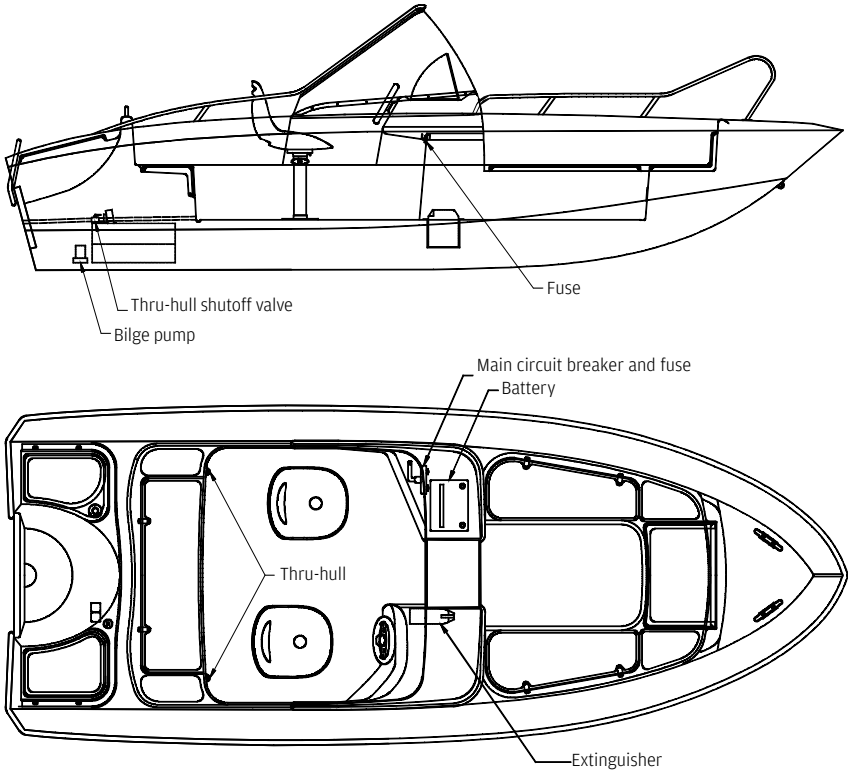

Fig. 5. Location of thru-hulls, shutoff valves and bilge pumps.

Silver Hawk BR 540



40 Fig. 5. Location of thru-hulls, shutoff valves and bilge pumps.

Silver Shark CC 580
Silver Eagle CC 630

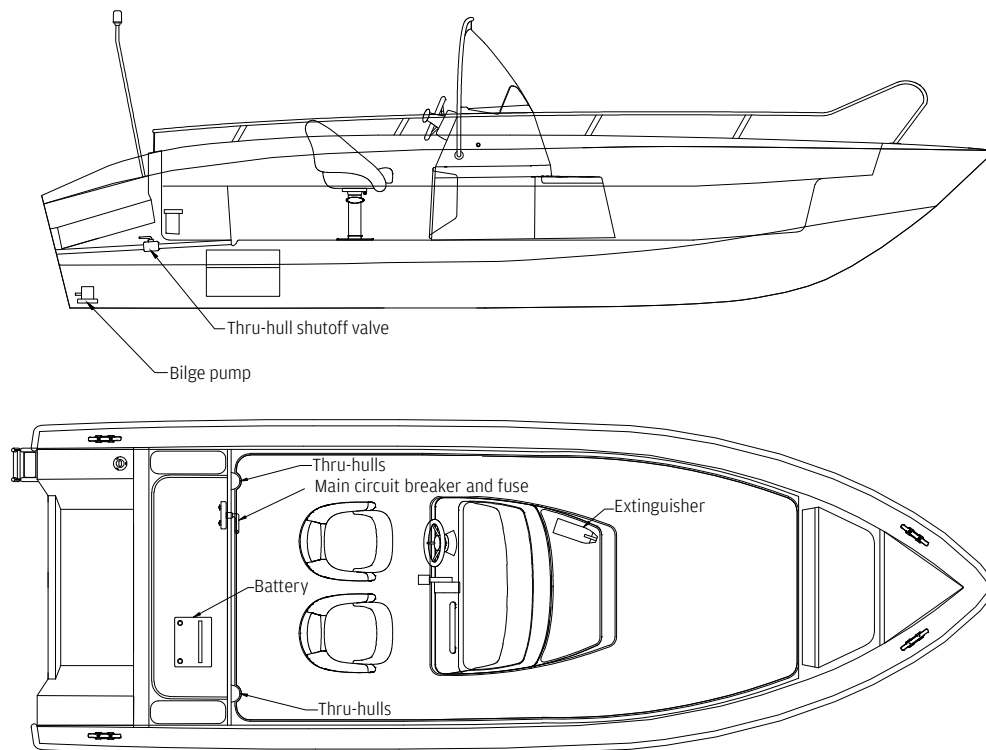
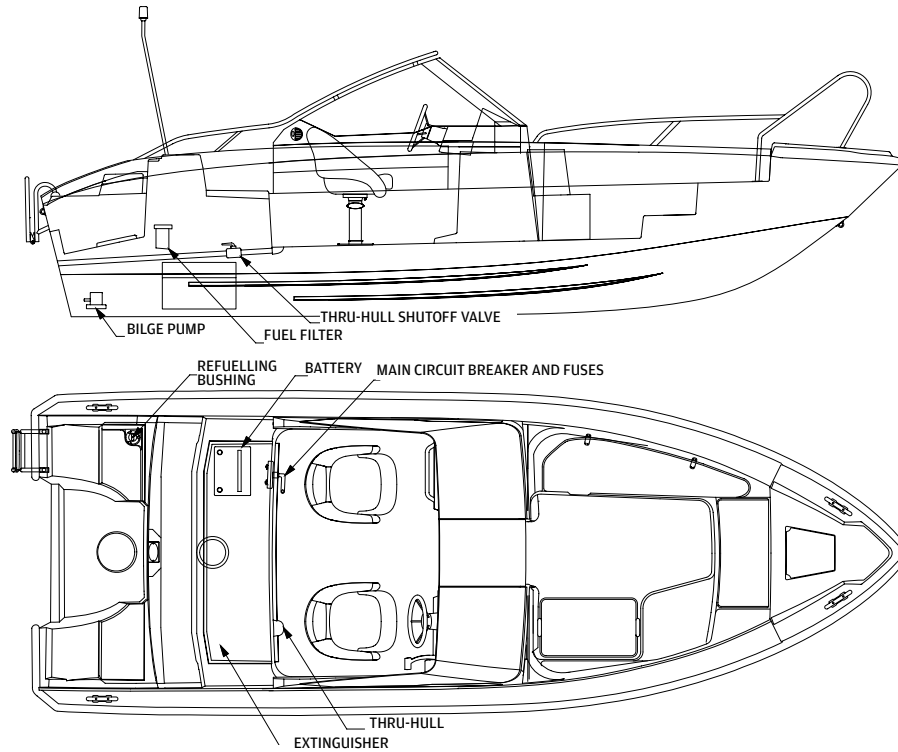

Fig. 5. Location of thru-hulls, shutoff valves and bilge pumps.

Silver Shark BR 580



42 Fig. 5. Location of thru-hulls, shutoff valves and bilge pumps.

Silver Eagle BR 650

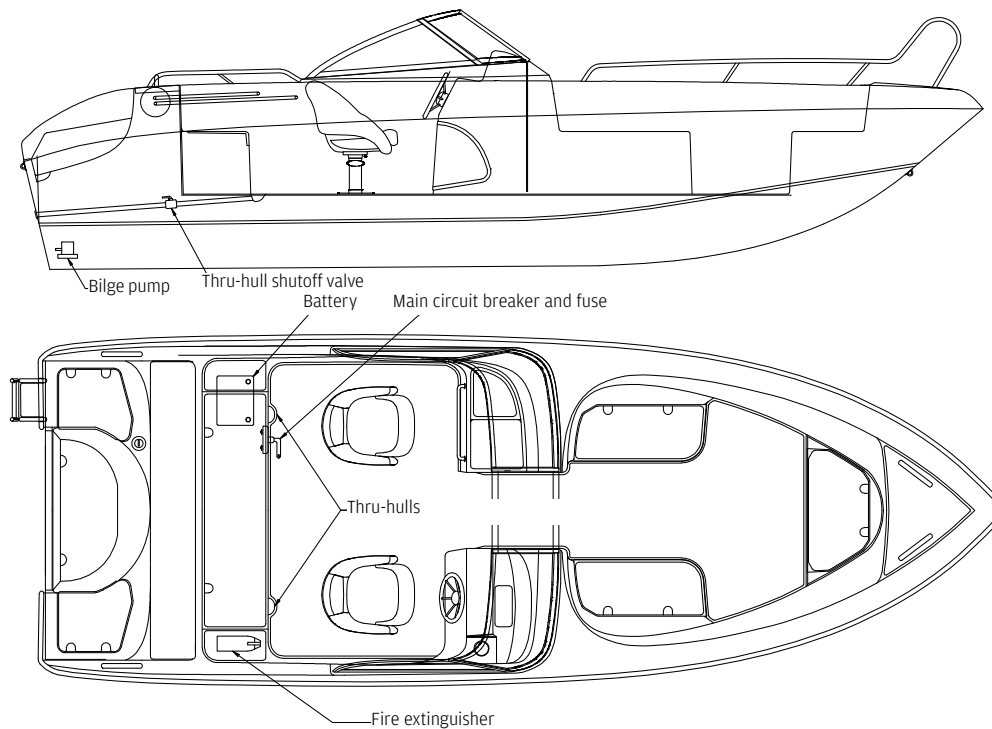
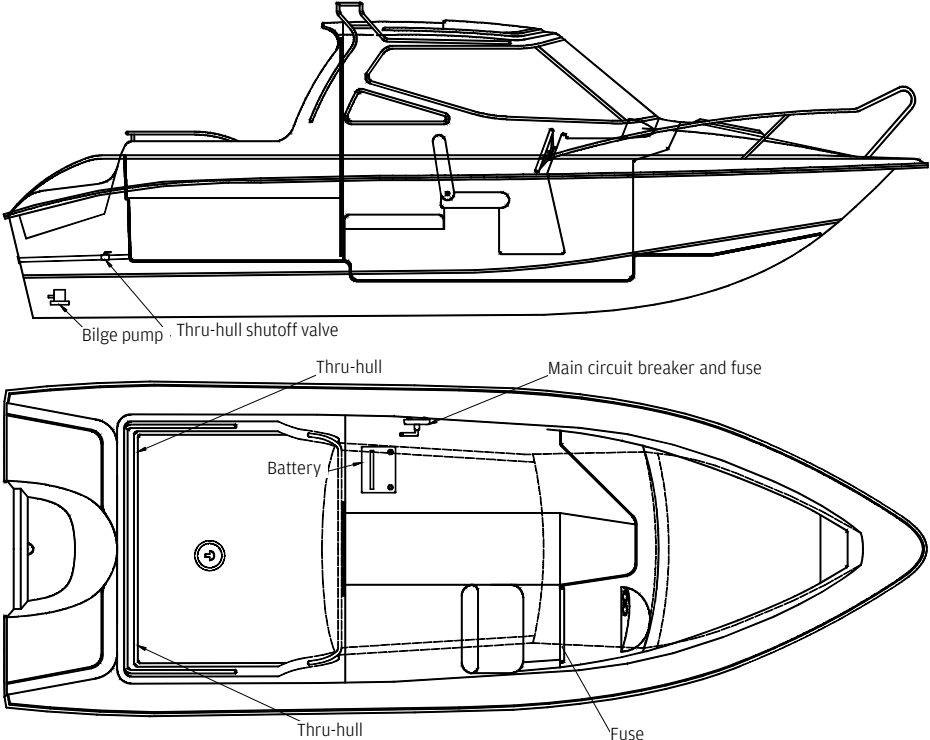

Fig. 5. Location of thru-hulls, shutoff valves and bilge pumps.

Silver Star Cabin 650



44 Fig. 5. Location of thru-hulls, shutoff valves and bilge pumps.

Silver Cabin 650

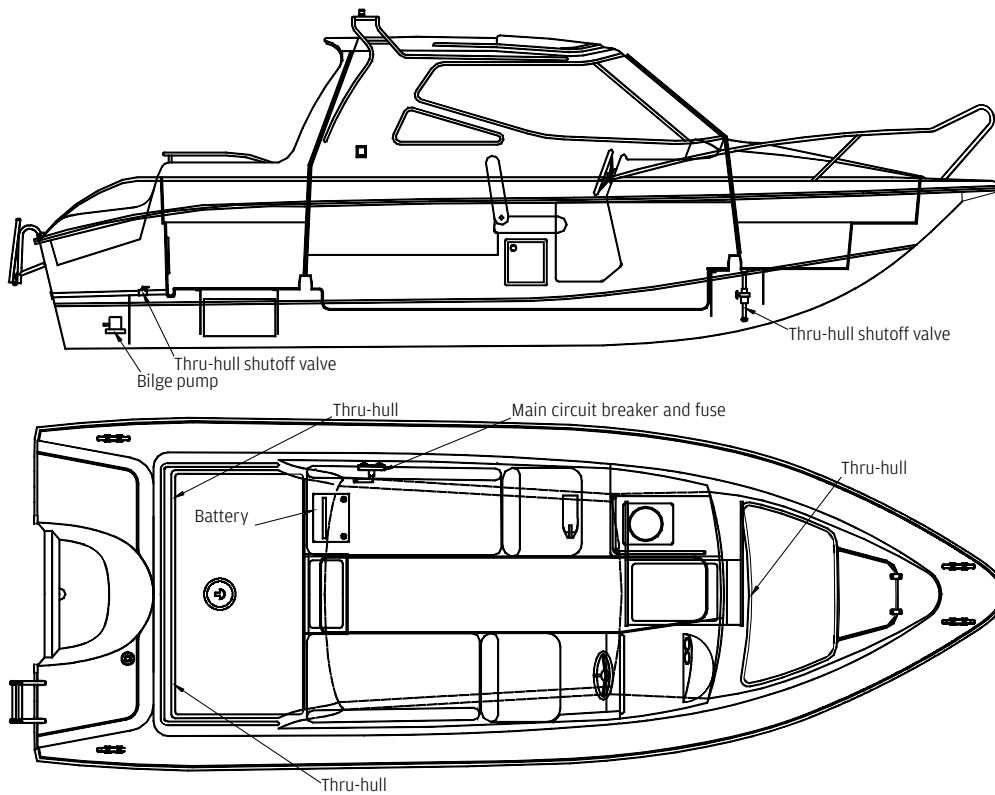
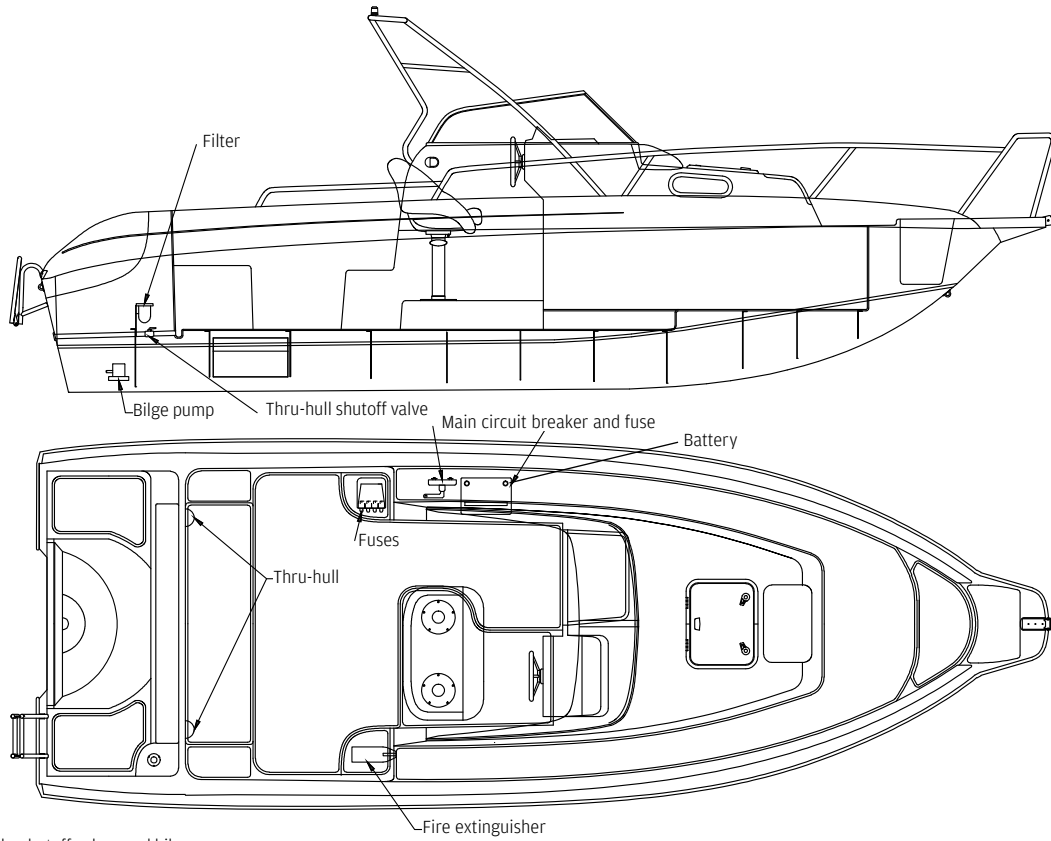

Fig. 5. Location of thru-hulls, shutoff valves and bilge pumps.

Silver Eagle WA 650



46 Fig. 5. Location of thru-hulls, shutoff valves and bilge pumps.

Silver Condor 730

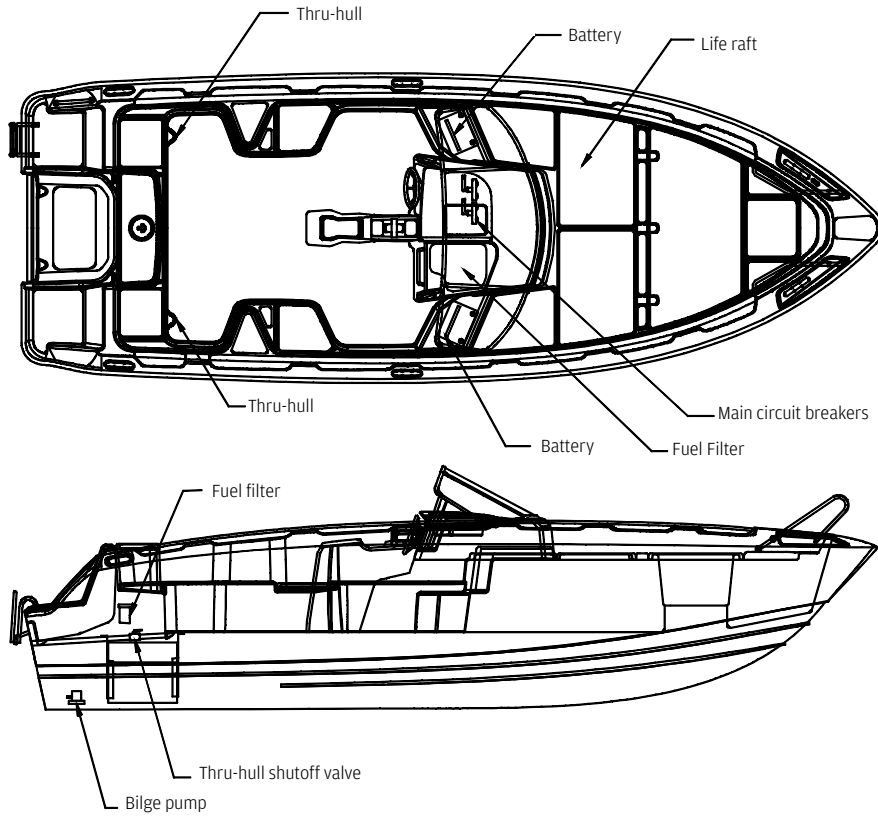

Fig. 5. Location of thru-hulls, shutoff valves and bilge pumps.

TECHNICAL SPECIFICATIONS	BEAVER 450	FOX DC 485	FOX BR 485	WOLF DC 510	WOLF BR 510	HAWK CC/BR 540	SHARK CC 580	SHARK BR 580	EAGLE CC 630	EAGLE BR 650	CABIN 650	STAR CABIN 650	EAGLE WA 650	CONDOR 730
Length cm	450	485	485	510	510	540	580	580	630	650	650	650	650	727
Beam cm	181	195	195	198	198	217	225	225	240	240	240	240	240	261
Weight kg	300	400	420	480	520	550/ 570	660	720	650	810	1000	900	900	1440
Draught cm	24	25	25	33	33	28	30	30	30	32	32	32	32	43
Bottom chine angle°	15,5	18	18	18,2	18,2	18,5	17,5	17,5	18,5	18,5	18,5	18,5	18,5	21
Fuel tank capacity litres	-	-	-	-	-	105	130	130	130	130	130	130	130	340
Steering cable cm	210	330	390	365	365	420/ 360	420	420	-	-	-	-	-	-
Remote control cable cm	240	365	420	365	365	450/ 330	510/ 360	360	510/ 360	480	510	510	510	-
Hydraulic steering cable cm	-	-	-	400	400	420	600	600	600	600	600	600	600	600

ADDITIONAL INFORMATION	BEAVER 450	FOX DC 485	FOX BR 485	WOLF DC 510	WOLF BR 510	HAWK CC/BR 540	SHARK CC 580	SHARK BR 580	EAGLE CC 630	EAGLE BR 650	CABIN 650	STAR CABIN 650	EAGLE WA 650	CONDOR 730
EU leisure boat standard	yes	yes	yes	yes	yes	yes	yes	yes	yes	yes	yes	yes	yes	yes
CE marking design category	C	C	C	C	C	C	C	C	C	C	C	C	C	C
Self-bailing	yes	yes	yes	yes	yes	yes	yes	yes	yes	yes	yes	yes	yes	yes
Number of passengers	5	5	5	6	6	7	7	7	7	7	7	6	7	8
Recommended engine size kW (hp)	30 kW (40hp)	37 kW (50hp)	45 kW (60hp)	45Kw (60 hp)	45Kw (60 hp)	75 kW (100hp)	86 kW (115hp)	86 kW (115hp)	112 kW (150hp)	130 kW (175 hp)	112 kW (150 hv)	112 kW (150 hp)	130 kW (175 hp)	220 kW (300 hp)
Maximum load recommended kg	405	435	435	500	500	615	525	525	635	675	625	450	675	1005
Hull material marine aluminium	yes	yes	yes	yes	yes	yes	yes	yes	yes	yes	yes	yes	yes	yes

Minor variations in measures and weights may occur due to production techniques.

Owing to the manufacturing methods used to make the aluminium hull, the bottom of the boat and sides may give rise to small variations which have no affect on the boat's features and usability.

Circuit diagram: Beaver

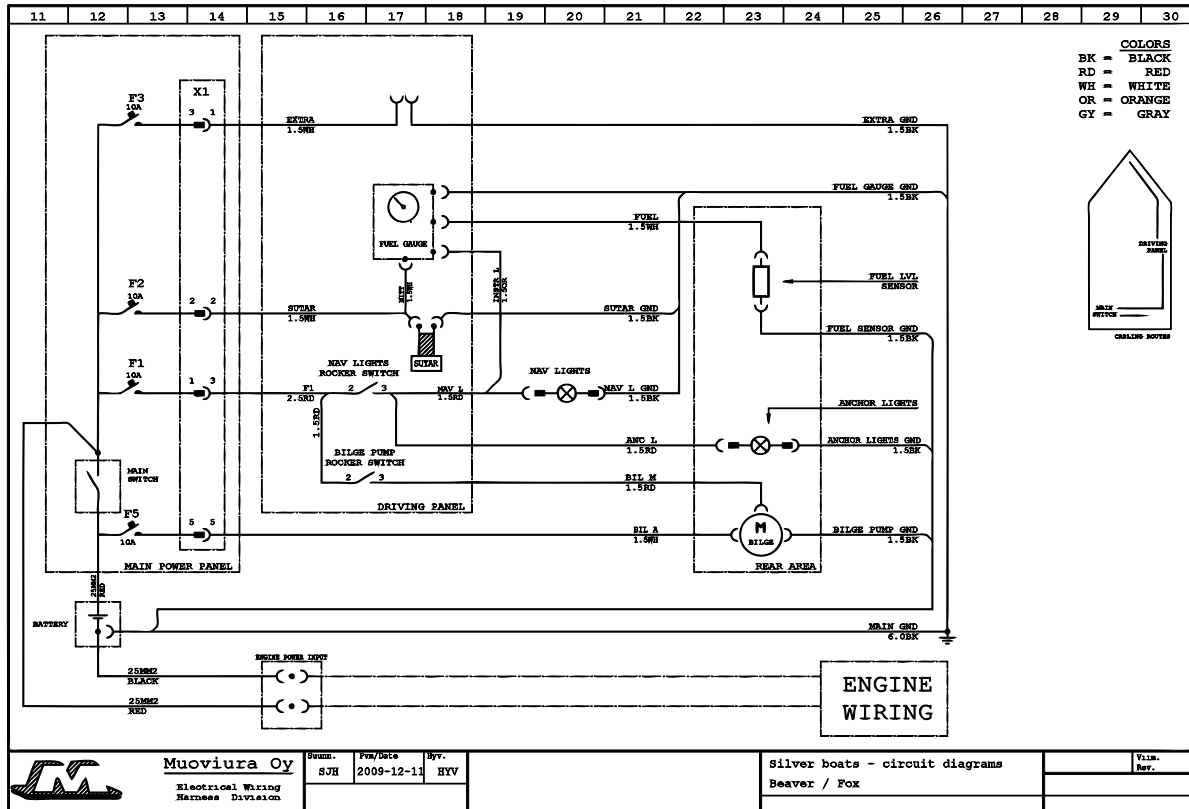

50

Fig. 6. Circuit diagram

Circuit diagram: Fox DC/BR

CIN FI-SLVFB050-056J213, CIN FI-SLVFB057-112K213, CIN FI-SLVFB118J213, CIN FI-SLVFD065-115L213, CIN FI-SLVFD116-117L213

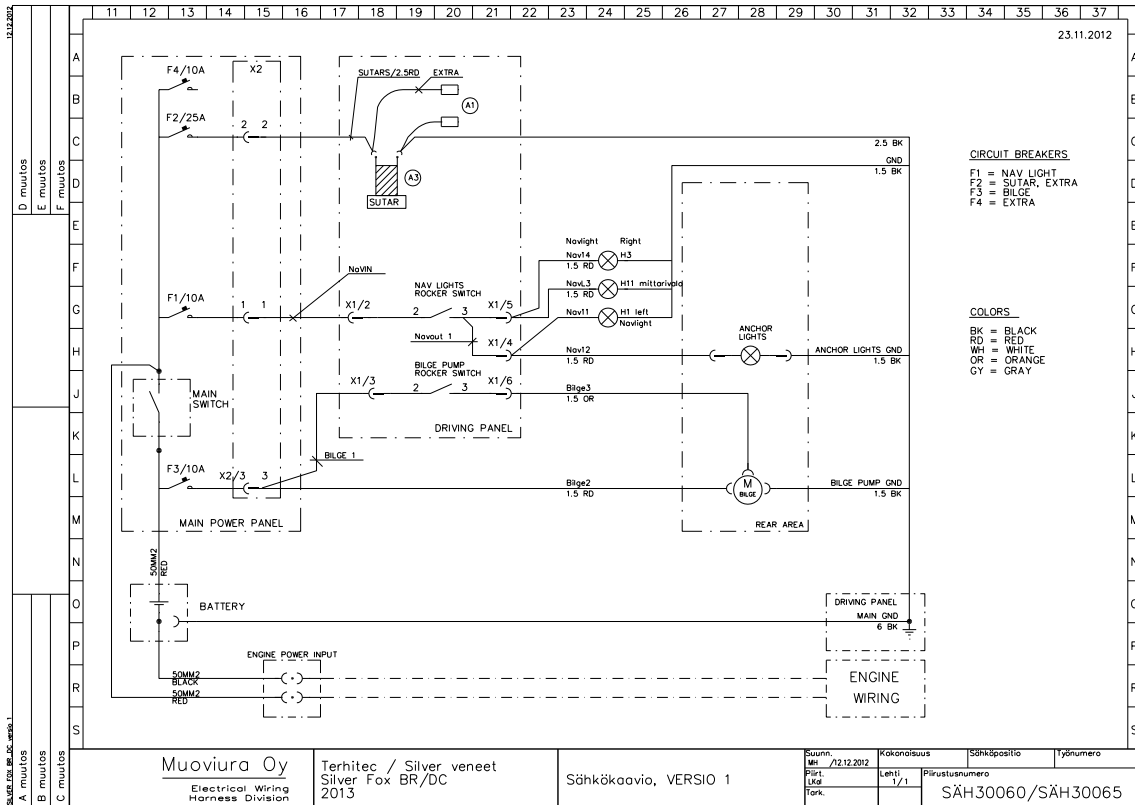

ENGLISH

Circuit diagram: Fox DC/BR

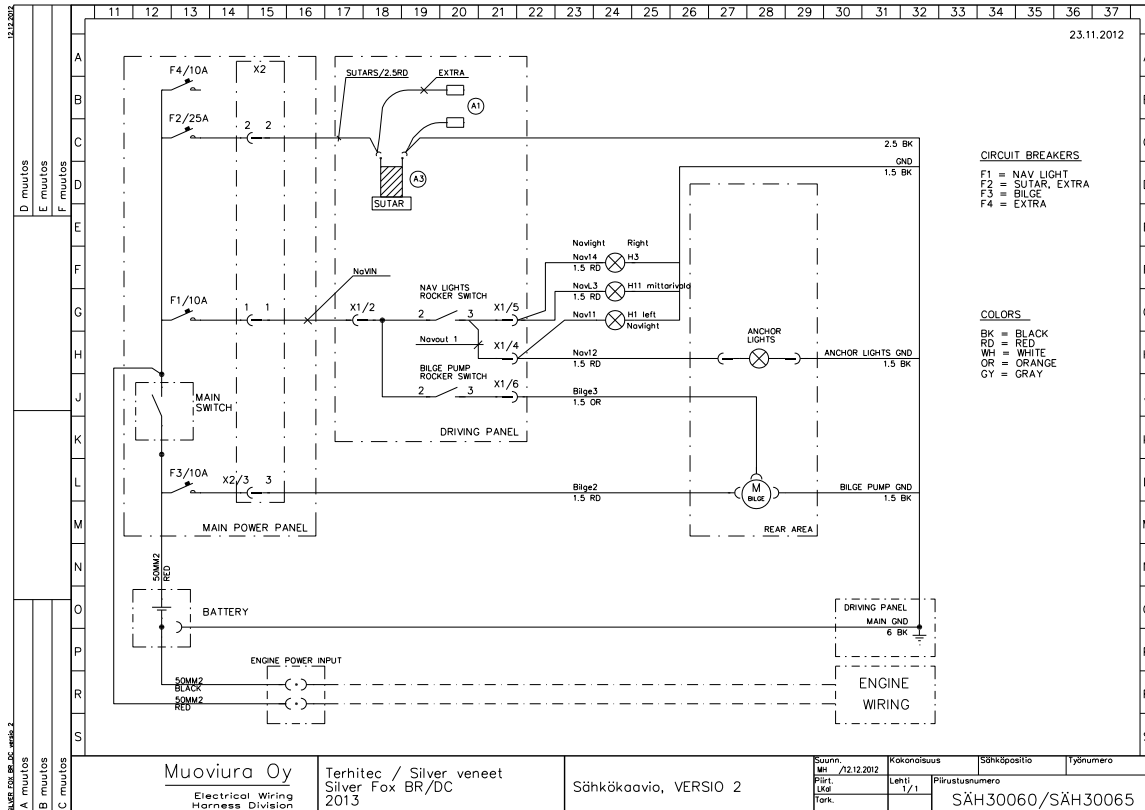

Circuit diagram: Wolf DC/BR

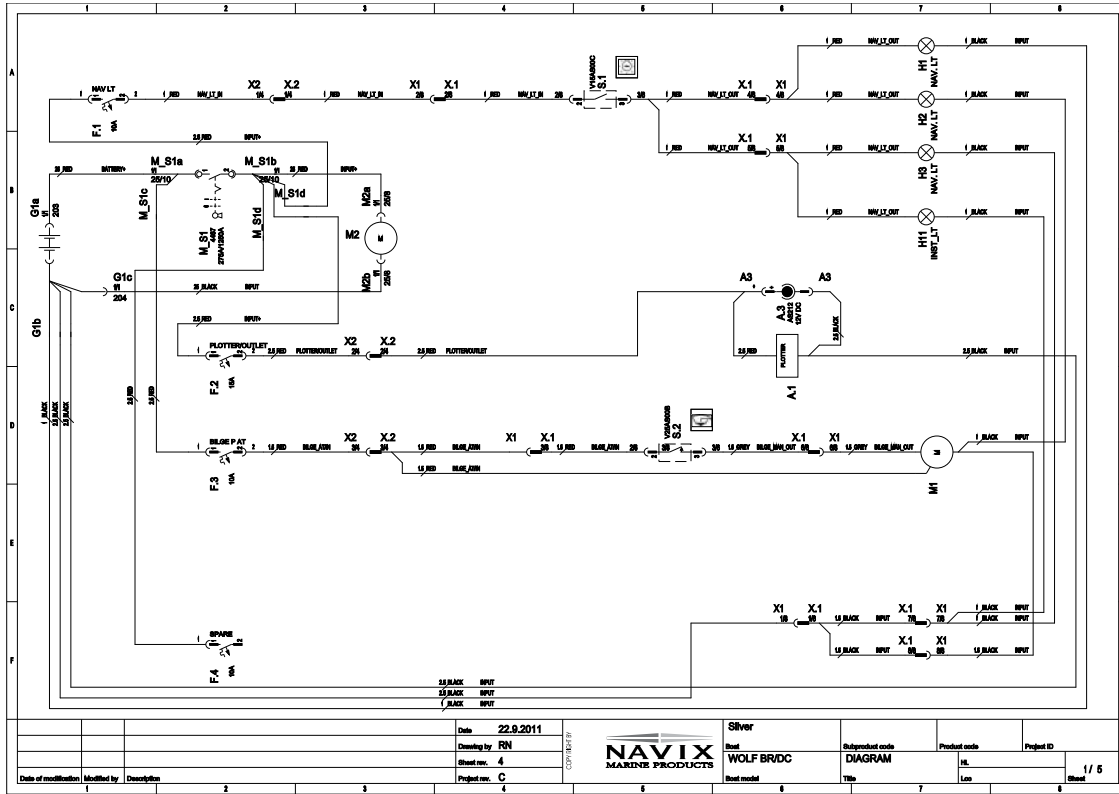

Tank diagram

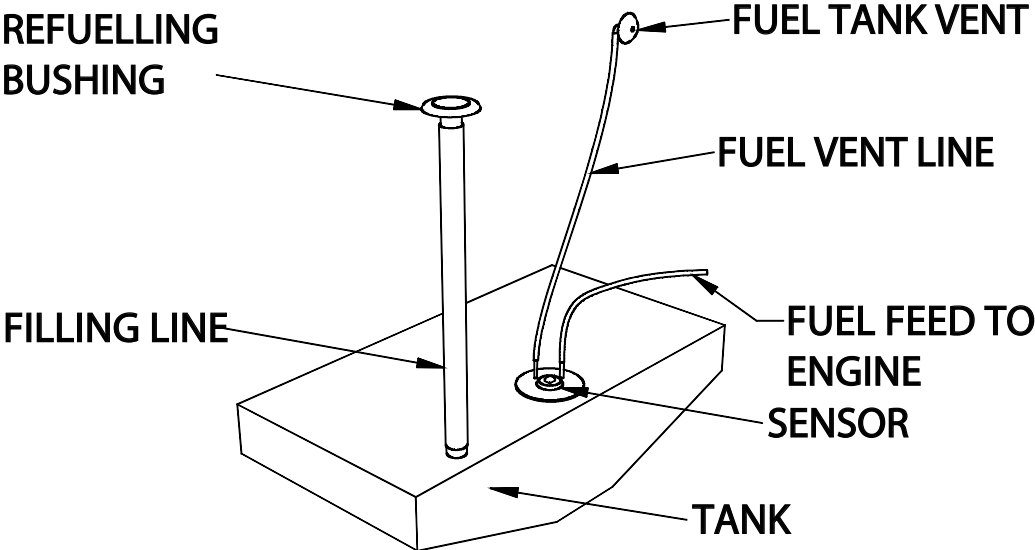

Essential safety requirements in the Recreational Craft Directive listed according to inspection category

		Standards applied		
		Silver Beaver 450	Silver Fox DC 485	Silver Fox BR 485
	General requirements			
	Principal data	EN ISO 8666:2002	EN ISO 8666:2002	EN ISO 8666:2002
2.1	Hull identification	ISO 10087:1996 / A1 2000	ISO 10087:1996 / A1 2000	ISO 10087:1996 / A1 2000
2.2	Builder's plate	RCD annex I, 2.2	RCD annex I, 2.2	RCD annex I, 2.2
2.5	Owner's manual	EN ISO 10240:2004	EN ISO 10240:2004	EN ISO 10240:2004
	Arrangement and equipments			
2.3	Protection from falling overboard	EN ISO 15085:2003	EN ISO 15085:2003	EN ISO 15085:2003
3.7	Life raft stowage			
3.8	Escape			
3.9	Anchoring, mooring and towing	EN ISO 15084:2003	EN ISO 15084:2003	EN ISO 15084:2003
5.7	Navigation lights	1972 COLREG	1972 COLREG	1972 COLREG
5.8	Discharge prevention			
	Installations			
5.1	Engine and engine spaces			
5.2	Fuel system	EN ISO 10088:2001, EN ISO 11105:1997	EN ISO 10088:2001, EN ISO 11105:1997	EN ISO 10088:2001, EN ISO 11105:1997
5.3	Electrical system	EN ISO 10133:2000, ISO 8846:1990	EN ISO 10133:2000, ISO 8846:1990	EN ISO 10133:2000, ISO 8846:1990
5.4	Steering system	EN ISO 28848 + A1:2000	EN ISO 28848 + A1:2000	EN ISO 28848 + A1:2000
5.5	Gas system			
5.6	Fire protection	EN ISO 9094-1:2003	EN ISO 9094-1:2003	EN ISO 9094-1:2003
	Structural requirements			
3.1	Structure	RSG Guidelines, NBS-VTT Extended rule	RSG Guidelines, NBS-VTT Extended rule	RSG Guidelines, NBS-VTT Extended rule
	Hydrostatic			
3.2	Stability and freeboard	EN ISO 12217:2002	EN ISO 12217:2002	EN ISO 12217:2002
3.3	Buoyancy and flotation	EN ISO 12217:2002	EN ISO 12217:2002	EN ISO 12217:2002
3.6	Manufacturer's max. recommended load	EN ISO 12217:2002, EN ISO 14946:2001	EN ISO 12217:2002, EN ISO 14946:2001	EN ISO 12217:2002, EN ISO 14946:2001
3.4	Openings in hull, deck and superstruct.			
3.5	Flooding			
	Handling characteristics			
4	Handling characteristics	EN ISO 11592:2001	EN ISO 11592:2001	EN ISO 11592:2001
2.4	Visibility from the main steering position	RSG Guidelines, NBS F10	RSG Guidelines, NBS F10	RSG Guidelines, NBS F10

Essential safety requirements in the Recreational Craft Directive listed according to inspection category

		Standards applied			
		Silver Wolf DC/BR 510	Silver Hawk 540 BR/CC	Silver Shark 580 BR/CC	Silver Eagle 630 CC
	General requirements				
	Principal data	EN ISO 8666:2002	EN ISO 8666:2002	EN ISO 8666:2002	EN ISO 8666:2002
2.1	Hull identification	ISO 10087:1996 / A1 2000	ISO 10087:1996 / A1 2000	ISO 10087:1996 / A1 2000	ISO 10087:1996 / A1 2000
2.2	Builder's plate	RCD annex I, 2.2	RCD annex I, 2.2	RCD annex I, 2.2	RCD annex I, 2.2
2.5	Owner's manual	EN ISO 10240:2004	EN ISO 10240:2004	EN ISO 10240:2004	EN ISO 10240:2004
	Arrangement and equipments				
2.3	Protection from falling overboard	EN ISO 15085:2003/A1:2009	EN ISO 15085:2003	EN ISO 15085:2003	EN ISO 15085:2003
3.7	Life raft stowage				RSG Guidelines
3.8	Escape				
3.9	Anchoring, mooring and towing	EN ISO 15084:2003	EN ISO 15084:2003	EN ISO 15084:2003	EN ISO 15084:2003
5.7	Navigation lights	1972 COLREG	1972 COLREG	1972 COLREG	1972 COLREG
5.8	Discharge prevention				
	Installations				
5.1	Engine and engine spaces				EN ISO 11105:1997
5.2	Fuel system	EN ISO 11105:1997	EN ISO 10088:2001, EN ISO 11105:1997	EN ISO 10088:2001, EN ISO 11105:1997	EN ISO 10088:2001, EN ISO 11105:1997
5.3	Electrical system	EN ISO 10133:2000, EN ISO 28846:1993/A1:2000	EN ISO 10133:2000, ISO 8846:1990	EN ISO 10133:2000, ISO 8846:1990	EN ISO 10133:2000, ISO 8846:1990
5.4	Steering system	EN ISO 28848 + A1:2000	EN ISO 28848 + A1:2000, EN ISO 10592:1995	EN ISO 28848 + A1:2000, EN ISO 10592:1995	EN ISO 10592:1995
5.5	Gas system				
5.6	Fire protection	EN ISO 9094-1:2003	EN ISO 9094-1:2003	EN ISO 9094-1:2003	EN ISO 9094-1:2003
	Structural requirements				
3.1	Structure	RSG Guidelines, NBS-VTT Extended rule	RSG Guidelines, NBS-VTT Extended rule	RSG Guidelines, NBS-VTT Extended rule	RSG Guidelines, NBS-VTT Extended rule
	Hydrostatic				
3.2	Stability and freeboard	EN ISO 12217-3:2002 + A1:2009	EN ISO 12217:2002	EN ISO 12217:2002	EN ISO 12217:2002
3.3	Buoyancy and flotation	EN ISO 1221-3:2002	EN ISO 12217:2002	EN ISO 12217:2002	
3.6	Manufacturer's max. recommended load	EN ISO 14946:2001/AC 2005	EN ISO 12217:2002, EN ISO 14946:2001	EN ISO 12217:2002, EN ISO 14946:2001	EN ISO 12217:2002, EN ISO 14946:2001
3.4	Openings in hull, deck and superstruct.	EN ISO 9093-1:1997			
3.5	Flooding	EN ISO 15083:2003, ISO 8849			
	Handling characteristics				
4	Handling characteristics	EN ISO 11592:2001, EN ISO 8665:2006	EN ISO 11592:2001	EN ISO 11592:2001	EN ISO 11592:2001
2.4	Visibility from the main steering position	EN ISO 11591:2000	RSG Guidelines, NBS F10	RSG Guidelines, NBS F10	RSG Guidelines, NBS F10

Essential safety requirements in the Recreational Craft Directive listed according to inspection category

		Standards applied			
		Silver Eagle BR 650	Silver Cabin 650	Silver Cabin DTI	Silver Star Cabin 650
	General requirements				
	Principal data	EN ISO 8666:2002	EN ISO 8666:2002	EN ISO 8666:2002	EN ISO 8666:2002
2.1	Hull identification	ISO 10087:1996 / A1 2000	ISO 10087:1996 / A1 2000	ISO 10087:1996 / A1 2000	ISO 10087:1996 / A1 2000
2.2	Builder's plate	RCD annex I, 2.2	RCD annex I, 2.2	RCD annex I, 2.2	RCD annex I, 2.2
2.5	Owner's manual	EN ISO 10240:2004	EN ISO 10240:2004	EN ISO 10240:2004	EN ISO 10240:2004
	Arrangement and equipments				
2.3	Protection from falling overboard	EN ISO 15085:2003	EN ISO 15085:2003	EN ISO 15085:2003	EN ISO 15085:2003
3.7	Life raft stowage	RSG Guidelines	RSG Guidelines	RSG Guidelines	RSG Guidelines
3.8	Escape	EN ISO 9094-1:2003	EN ISO 9094-1:2003	EN ISO 9094-1:2003	EN ISO 9094-1:2003
3.9	Anchoring, mooring and towing	EN ISO 15084:2003	EN ISO 15084:2003	EN ISO 15084:2003	EN ISO 15084:2003
5.7	Navigation lights	1972 COLREG	1972 COLREG	1972 COLREG	1972 COLREG
5.8	Discharge prevention			EN ISO 8099:2000	
	Installations				
5.1	Engine and engine spaces			EN ISO 11105:1997	
5.2	Fuel system	EN ISO 10088:2001, EN ISO 11105:1997	EN ISO 10088:2001, EN ISO 11105:1997	EN ISO 10088:2001, EN ISO 11105:1997	EN ISO 10088:2001, EN ISO 11105:1997
5.3	Electrical system	EN ISO 10133:2000, ISO 8846:1990	EN ISO 10133:2000,, ISO 8846:1990	EN ISO 10133:2000, ISO 8846:1990	EN ISO 10133:2000, ISO 8846:1990
5.4	Steering system	EN ISO 10592:1995	EN ISO 10592:1995	EN ISO 10592:1995	EN ISO 10592:1995
5.5	Gas system				
5.6	Fire protection	EN ISO 9094-1:2003	EN ISO 9094-1:2003	EN ISO 9094-1:2003	EN ISO 9094-1:2003
	Structural requirements				
3.1	Structure	RSG Guidelines, NBS-VTT Extended rule	RSG Guidelines, NBS-VTT Extended rule	RSG Guidelines, NBS-VTT Extended rule	RSG Guidelines, NBS-VTT Extended rule
	Hydrostatic				
3.2	Stability and freeboard	EN ISO 12217:2002	EN ISO 12217:2002	EN ISO 12217:2002	EN ISO 12217:2002
3.3	Buoyancy and flotation				
3.6	Manufacturer's max. recommended load	EN ISO 12217:2002, EN ISO 14946:2001	EN ISO 12217:2002, EN ISO 14946:2001	EN ISO 12217:2002, EN ISO 14946:2001	EN ISO 12217:2002, EN ISO 14946:2001
3.4	Openings in hull, deck and superstruct				
3.5	Flooding	EN ISO 15083:2003			
	Handling characteristics				
4	Handling characteristics	EN ISO 11592:2001	EN ISO 11592:2001	EN ISO 11592:2001	EN ISO 11592:2001
2.4	Visibility from the main steering position	RSG Guidelines, NBS F10	RSG Guidelines, NBS F10	RSG Guidelines, NBS F10	RSG Guidelines, NBS F10

Essential safety requirements in the Recreational Craft Directive listed according to inspection category

		Standards applied		
		Silver Star Cabin DTI	Silver Eagle WA 650	Silver Condor 730
	General requirements			
	Principal data	EN ISO 8666:2002	EN ISO 8666:2002	EN ISO 8666:2002
2.1	Hull identification	ISO 10087:1996 / A1 2000	ISO 10087:1996 / A1 2000	ISO 10087:1996 / A1 2000
2.2	Builder's plate	RCD annex I, 2.2	RCD annex I, 2.2	RCD annex I, 2.2
2.5	Owner's manual	EN ISO 10240:2004	EN ISO 10240:2004	EN ISO 10240:2004
	Arrangement and equipments			
2.3	Protection from falling overboard	EN ISO 15085:2003	EN ISO 15085:2003	EN ISO 15085:2003
3.7	Life raft stowage	RSG Guidelines	RSG Guidelines	RSG Guidelines
3.8	Escape	EN ISO 9094-1:2003	EN ISO 9094-1:2003	EN ISO 9094-1:2003
3.9	Anchoring, mooring and towing	EN ISO 15084:2003	EN ISO 15084:2003	EN ISO 15084:2003
5.7	Navigation lights	1972 COLREG	1972 COLREG	1972 COLREG
5.8	Discharge prevention	EN ISO 8099:2000		
	Installations			
5.1	Engine and engine spaces	EN ISO 11105:1997		
5.2	Fuel system	EN ISO 10088:2001, EN ISO 11105:1997	EN ISO 10088:2001, EN ISO 11105:1997	EN ISO 10088:2001, EN ISO 11105:1997
5.3	Electrical system	EN ISO 10133:2000, ISO 8846:1990	EN ISO 10133:2000, ISO 8846:1990	EN ISO 10133:2000, ISO 8846:1990
5.4	Steering system	EN ISO 10592:1995	EN ISO 10592:1995	EN ISO 10592:1995
5.5	Gas system			
5.6	Fire protection	EN ISO 9094-1:2003	EN ISO 9094-1:2003	EN ISO 9094-1:2003
	Structural requirements			
3.1	Structure	RSG Guidelines, NBS-VTT Extended rule	RSG Guidelines, NBS-VTT Extended rule	RSG Guidelines, NBS-VTT Extended rule
	Hydrostatic			
3.2	Stability and freeboard	EN ISO 12217:2002	EN ISO 12217:2002	EN ISO 12217:2002
3.3	Buoyancy and flotation			
3.6	Manufacturer's max. recommended load	EN ISO 12217:2002, EN ISO 14946:2001	EN ISO 12217:2002, EN ISO 14946:2001	EN ISO 12217:2002, EN ISO 14946:2001
3.4	Openings in hull, deck and superstruct.			
3.5	Flooding		EN ISO 15083:2003	EN ISO 15083:2003
	Handling characteristics			
4	Handling characteristics	EN ISO 11592:2001	EN ISO 11592:2001	EN ISO 11592:2001
2.4	Visibility from the main steering position	RSG Guidelines, NBS F10	RSG Guidelines, NBS F10	RSG Guidelines, NBS F10

Declaration of Conformity

Recreational Craft Directive 94/25/EY and 2003/44/EY

MANUFACTURER

Manufacturer's name: TerhiTec Oy
Address: Sorvitie 4
Post code: FI-63700
City: Ähtäri
Country: Finland
Module used: B+C, Aa

NOTIFIED BODY

Name: VTT Expert Services Oy
Distinguishing number: 0537
Address: PL 1001
Post code: FI-02044 VTT
City: Espoo
Country: Finland

Name: International Marine Certification Institute (IMCI)
Distinguishing number: 0609
Address: Rue Abbé Cuypers 3
Post code: B-1040
City: Brussels
Country: Belgium

Craft make and model	Design category	Type-examination certificate no:	Type of craft	Construction material	Max. engine power (kW)	Length/beam/draught (m)
Silver Beaver	C	VTT-C-4981-10-vene-002-10	Open craft with outboard engine	Aluminium alloys Reinforced plastic	30	4,50/1,81/0,24
Silver Fox DC	C	VTT-C-4999-10-vene-002-10			37	4,85/1,95/0,25
Silver Fox BR	C	VTT-C-4998-10-vene-003-10			45	4,85/1,95/0,25
Silver Wolf	C	VTT-C-7653-10-vene-001-11			45	5,09/1,98/0,3
Silver Hawk BR/CC	C	VTT-C-5001-10-vene-002-10			75	5,40/2,17/0,28
Silver Shark BR/CC	C	BBSKVVT002			86	5,80/2,25/0,30
Silver Eagle BR 650	C	VTT-C-5027-10-vene-002-10			130	6,30/2,40/0,30
Silver Eagle CC	C	VTT-C-4995-10-vene-003-10			112	6,30/2,40/0,30
Silver Condor	C	VTT-C-4982-10-vene-002-10			220	7,26/2,60/0,50
Silver Eagle Star Cabin	C	BBSKVVT001			Decked craft with outboard engine	112
Silver Eagle WA	C	VTT-C-4994-10-vene-002-10	130	6,50/2,40/0,32		
Silver Eagle Cabin	C	VTT-C-4997-10-vene-002-10	112	6,50/2,40/0,32		
Silver Eagle Star Cabin DTI	C	BSILVER003	Decked craft with inboard engine	86	6,50/2,40/0,32	
Silver Eagle Cabin DTI	C	VTT-C-4996-10-vene-003-10		86	6,50/2,40/0,32	

64 I hereby declare that the recreational craft identified above satisfy all the relevant essential requirements in accordance with the itemised list on the reverse of this document (including the EC type-examination certificate, if such a certificate has been issued).



Jarmo Sundin, Managing director
Date: January 3, 2012

Notes

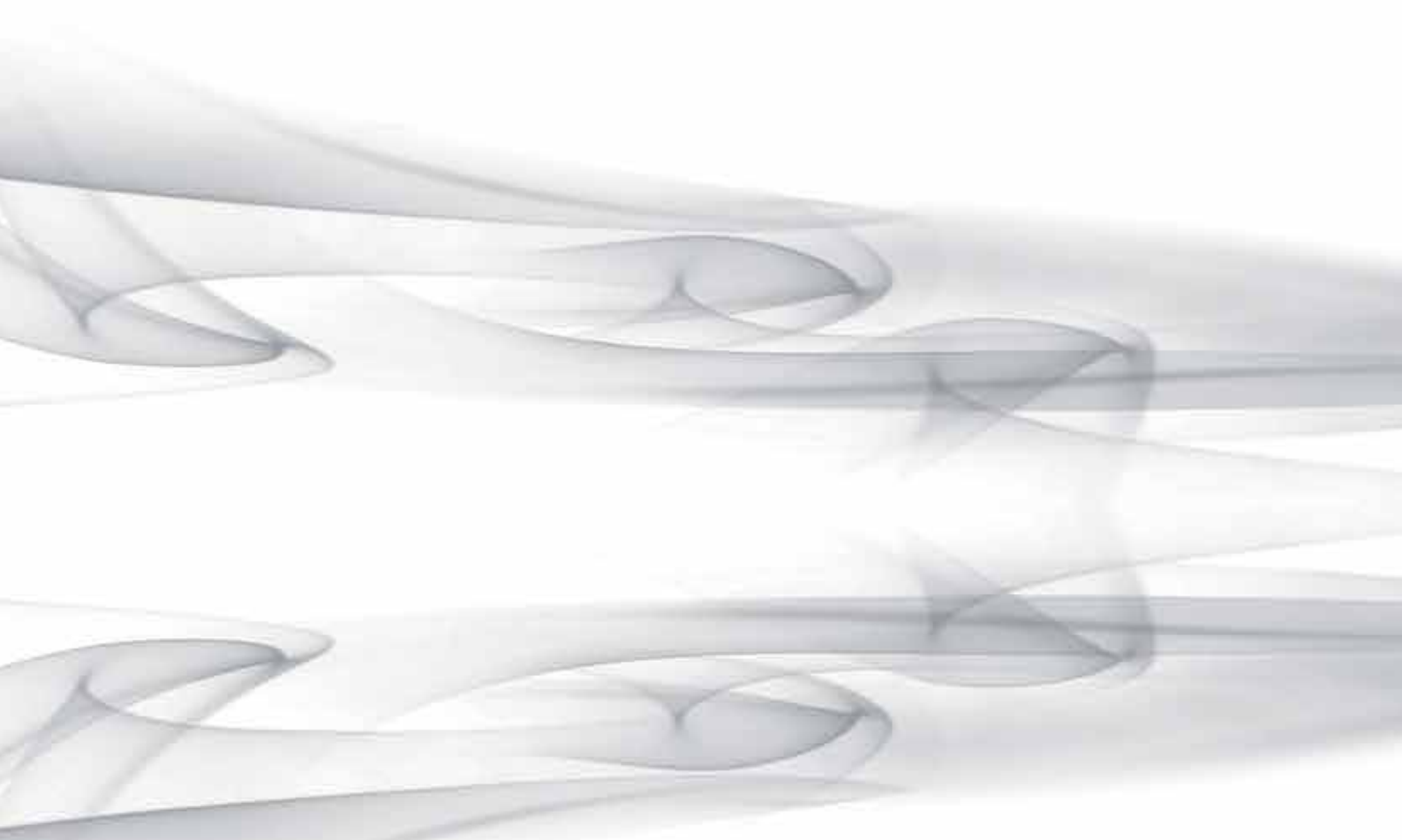

Silver[®]
The AluFibre™ Boat

www.silverboats.fi
Finland

TERHITEC
www.terhitec.fi